

RICOH

PJ X3241N PJ WX3231N DATA PROJECTOR

OWNER'S MANUAL

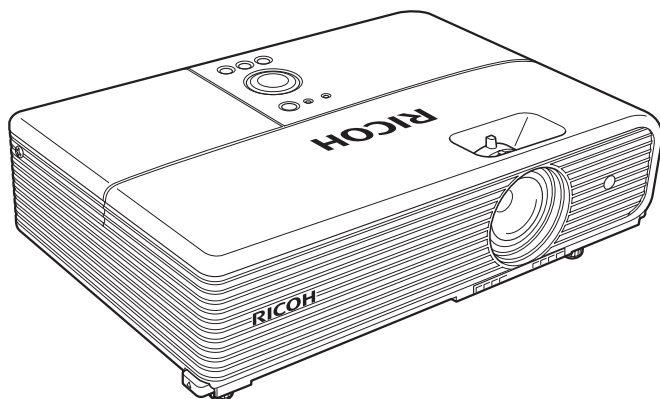

HDMI™

For safe and correct use, be sure to read “Before Using” before using the machine. In the spaces provided below, record the Model and Serial No. located at the bottom of your projector.

Model No. _____ Serial No. _____

Retain this information for future reference.

Before Using

Preparations

Operations

Network/
USB memory

Maintenance

Others

SAFETY PRECAUTIONS



The lightning flash with arrowhead symbol, within an equilateral triangle, is intended to alert the user to the presence of uninsulated “dangerous voltage” within the product’s enclosure that may be of sufficient magnitude to constitute a risk of electric shock to persons.



The exclamation point within an equilateral triangle is intended to alert the user to the presence of important operating and maintenance (servicing) instructions in the literature accompanying the appliance.

WARNING: TO REDUCE THE RISK OF FIRE OR ELECTRIC SHOCK, DO NOT EXPOSE THIS APPLIANCE TO RAIN OR MOISTURE. DANGEROUS HIGH VOLTAGES ARE PRESENT INSIDE THE ENCLOSURE. DO NOT OPEN THE CABINET. REFER SERVICING TO QUALIFIED PERSONNEL ONLY.

USA only LAMP(S) INSIDE THIS PRODUCT CONTAIN MERCURY AND MUST BE RECYCLED OR DISPOSED OF ACCORDING TO LOCAL, STATE OR FEDERAL LAWS.

MODEL NAME: PJ X3241N / PJ WX3231N **USA only**

TRADE NAME: DATA PROJECTOR
MODEL NAME: PJ X3241N / PJ WX3231N
FC Tested To Comply
With FCC Standards
FOR HOME OR OFFICE USE

FCC NOTICE: This device complies with part 15 of the FCC Rules. Operation is subject to the following two conditions:

(1) This device may not cause harmful interference, and (2) this device must accept any interference received, including interference that may cause undesired operation.

This equipment has been tested and found to comply with the limits for a Class B digital device, pursuant to part 15 of the FCC Rules. These limits are designed to provide reasonable protection against harmful interference in a residential installation. This equipment generates, uses and can radiate radio frequency energy and, if not installed and used in accordance with the instructions, may cause harmful interference to radio communications.

However, there is no guarantee that interference will not occur in a particular installation. If this equipment does cause harmful interference to radio or television reception, which can be determined by turning the equipment off and on, the user is encouraged to try to correct the interference by one or more of the following measures:

- Reorient or relocate the receiving antenna.
- Increase the separation between the equipment and receiver.
- Connect the equipment into an outlet on a circuit different from that to which the receiver is connected.
- Consult the sales representative or an experienced radio/TV technician for help.

RESPONSIBLE PARTY: Ricoh Americas Corporation

5 Dedrick Place, West Caldwell, NJ 07006

Phone: 973-882-2000

CAUTION: Changes or modifications made to this equipment, not expressly approved by **USA only** Ricoh, or parties authorized by Ricoh, could void the user's authority to operate the equipment.

Notice: This Class B digital apparatus complies with Canadian ICES-003. Cet appareil **CANADA only** numérique de la classe B est conforme à la norme NMB-003 du Canada.

IMPORTANT SAFETY INSTRUCTIONS

CAUTION: PLEASE READ AND OBSERVE ALL WARNINGS AND INSTRUCTIONS GIVEN IN THIS OWNER'S MANUAL AND THOSE MARKED ON THE UNIT. RETAIN THIS BOOKLET FOR FUTURE REFERENCE.

This unit is fully transistorized and does not contain any parts that can be repaired by the user.

WARNING: DO NOT REMOVE THE CABINET COVER, OR YOU MAY BE EXPOSED TO DANGEROUS VOLTAGE. REFER SERVICING TO QUALIFIED SERVICE PERSONNEL ONLY.

1. Read Owner's Manual

After unpacking this product, read the owner's manual carefully, and follow all the operating and other instructions.

2. Power Sources

This product should be operated only from the type of power source which does not exceed the voltage range specified on the rating label and the power cord.

If you are not sure of the type of power supply to your home, consult your sales representative or local power company.

3. Source of Light

Do not look into the lens while the lamp is on. The strong light from the lamp may cause damage to your eyesight.

4. Ventilation

Openings in the cabinet are provided for ventilation and to ensure reliable operation of the product and to protect it from overheating. These openings must not be blocked or covered. Never block an opening by placing the product on a bed, sofa, rug or other similar surface. Do not place it in a built-in installation such as a bookcase or rack, unless proper ventilation is provided.

5. Heat

The product should be situated away from heat sources such as radiators, heat registers, stoves, or other products (including amplifiers) that produce heat.

6. Water and Moisture

Do not use this product near water. - for example, near a bath tub, wash bowl, kitchen sink, or laundry tub; in a wet basement; or near a swimming pool and other similar environments.

7. Cleaning

Unplug this product from the wall outlet before cleaning. Do not use liquid cleaners or aerosol cleaners. Always use a soft cloth for cleaning.

8. Be sure that you firmly insert the plug into the wall outlet.

Incorrect or faulty connections may result in fire or electric shock. Avoid using an unsound or loose outlet.

9. Power Cord Protection

Power cords should be routed so that they are not likely to be walked on or pinched by items placed upon or against them, paying particular attention to cords at plugs, convenience receptacles, and the point where they exit from the product.

10. Overloading

Do not overload wall outlets. To reduce the risk of electric shock, do not use the polarized plug with an extension cord, receptacle, or other outlet unless the blades can be inserted completely with three-wire grounding type to prevent blade exposure. Failure to follow these instructions may result in fire or electric shock.

IMPORTANT SAFETY INSTRUCTIONS (Continued)

11. Lightning storms

For added protection for this product during a storm, or when it is left unattended and unused for long periods of time, unplug it from the wall outlet. This will prevent damage to the product due to lightning and power-line surges. Never operate this unit on AC power during a thunderstorm. If you see lightning or hear thunder, never touch the unit, cables and/or peripherals. An electric surge caused by the storm, may result in an electrical shock or damage to the unit.

12. Object and Liquid Entry

Never push objects of any kind into this product through openings as they may touch dangerous voltage points or short-out parts that could result in a fire or electric shock. Never spill liquid of any kind on the product.

13. Do not place or keep the projector within the reach of the children.

It may fall or tip over, possibly causing serious injury.

14. Do not place the product vertically

Do not use the product in the upright position or any other vertical positions to project the pictures. It may fall which could result in serious injury and/or damage to the product.

15. Stack Inhibited

Do not stack other equipment on this product and do not place this product on other equipment. The top and bottom surface of this product increase in temperature during normal use and may damage the other unit.

16. Attachments

Do not use attachments not recommended by the product manufacturer.

Use of an incompatible attachments could cause hazards or damage to the product.

17. Accessories

Do not place this product on an unstable cart, stand, tripod, bracket, or table. The product may fall, causing serious injury to a child or adult, and serious damage to the product. A product and cart combination should be moved with care. Quick stops, excessive force, and uneven surfaces may cause the product and cart combination to overturn.



S3125A

18. Damage Requiring Service

Unplug this product from the wall outlet and take the product to qualified service personnel if you encounter any of the following conditions:

- a) The power supply cord or plug is damaged.
- b) Liquid has been spilled, or objects have fallen into the product.
- c) The product has been exposed to rain or water.
- d) The product does not operate normally when following the operating instructions. Adjust only those controls that are covered by the operating instructions since an improper adjustment of other controls may result in damage and will often require extensive work by a qualified technician to restore the product to its normal operation.
- e) The product has been dropped or damaged in any way. (If the cabinet should break, please handle with care to avoid injury.)
- f) The product exhibits a distinct change in performance, which indicates a need for service.

19. If glass components, including lens and lamp, should break, contact your sales representative for repair service.

This product incorporates glass components, including a lens and a lamp.

If these should break, please handle with care to avoid injury and contact your sales representative for repair service. Avoid any broken pieces of glass since they may cause injury. In the unlikely event that the lamp ruptures, thoroughly clean the area around the projector and discard any edible items placed in that area since they may be contaminated.

20. Servicing

Do not attempt to service this product yourself as opening or removing covers may expose you to dangerous voltage or other hazards. Refer all servicing to qualified service personnel.

21. Do not place anything in front of the lens while the projector is operating

Things placed in front of the lens may overheat and burn or start a fire.

If you want to temporarily stop the projected image, use the mute on the remote control.

IMPORTANT SAFETY INSTRUCTIONS (Continued)

22. Replacement Parts

When replacement parts are required, be sure the service technician has used replacement parts specified by the manufacturer or have the same characteristics as the original part.

Unauthorized substitutions may result in fire, electric shock, or other hazards.

(Only the replacement of the lamp should be made by users.)

23. Safety Check

Upon completion of any service or repairs to this product, ask the service technician to perform safety checks to verify that the product is in proper operating condition.

24. Do not leave thermal-paper documents or easily deformed items on top of the unit or near the air exhaust for long periods of time.

The heat from the unit could erase the information on the thermal paper, or cause deformation or warping.

25. Do not use the product in a closed installation location.

Do not place the product in a box or in any other closed installation location. Otherwise it may overheat, which could result in a risk of fire.

26. When using a wireless LAN function:

- **Do not use near people with heart pacemakers.**
- **Do not use near electronic medical equipment, or in hospitals or other medical institutions.**
- **Do not use inside aircraft or in places where the wireless LAN function could interfere with electromagnetic signals.**

The electromagnetic interference could cause a malfunction, resulting in an accident.

27. If the use of a wireless LAN function interferes with another device's electromagnetic signals, cease use immediately.

The electromagnetic interference could cause a malfunction, resulting in an accident.

POWER SUPPLY INFORMATION

If your line voltage is 220 to 240 V, use one of the following types of cable/plug.

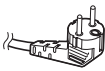
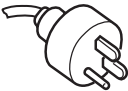
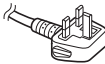
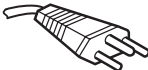
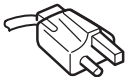
Plug configuration	Plug type	Line voltage	Plug configuration	Plug type	Line voltage
	EURO	220 – 240 V		Australian 240 V 10 A	200 – 240 V
	UK	220 – 240 V		Switzerland 240 V 6 A	200 – 240 V
				North American 200 – 240 V 15 A	200 – 240 V

Use a 5 A fuse which is approved by ASTA or BSI to BSI362.
Always replace the fuse cover after changing the fuse.

IMPORTANT PRECAUTIONS

Moisture Condensation

Never operate this unit immediately after moving it from a cold location to a warm location. When the unit is exposed to such a change in temperature, moisture may condense on the lens and the crucial internal parts. Do not use the unit for at least 2 hours when there is an extreme or sudden change in temperature to prevent the unit from possible damage.

Place and Manner of Installation

- Do not place in hot locations, such as near heating equipment. Doing so could cause a malfunction, and shorten the life of the projector.
- Avoid locations with oil or cigarette smoke. These environments will dirty the optical parts, shortening their lives, and darkening the screen.
- Do not use this product in the upright position or tilt it up or down by more than 20° from level. Doing so may cause a failure or shorten the life of the product.
- Using this instrument near a TV or radio may cause interference to the images or audio sound. If this happens, move it away from the TV or radio.
- In a high altitude location where air is thin, cooling efficiency is reduced so use the projector with **[Fan mode]** set to **[High]**. [p.43](#)
- Only plug the power cord into outlets rated for use within the power cord's specified voltage range. Do not overload extension cords or power strips as this can result in fire or electric shock.
- Route the power cable or the connecting cable away from where people could trip over it. The projector may fall, which could result in serious injury and/or damage to the product.
- Be sure the power cord is easily reached for unplugging in case of emergency. Do not place any obstacles near a wall outlet in which the cord is plugged.

Avoid Volatile Liquid

Do not use volatile liquids, such as an insect spray, near the unit. Do not leave rubber or plastic products touching the unit for a long time as they will leave marks on the finish. Do not use a chemically saturated cloth on the unit.

IMPORTANT PRECAUTIONS (Continued)

LCD Panel

- If the air filter is stained or clogged, the main unit inner temperature rises. As a result, the life of the LCD is shortened and a malfunction may also occur.
Clean the air filter from time to time and replace it regularly. It is recommended that you replace the filter at the time you replace the lamp. (Ask your sales representative where the unit was purchased or your nearby service station about an air filter for replacement.)

EXEMPTION CLAUSES

- Ricoh Corporation bears no responsibility in the case of damages arising from natural disaster such as earthquakes, lightning, etc., fire not liable to Ricoh Corporation, acts by third parties, other accidents, or use under abnormal conditions including erroneous or improper operation and other problems.
- Ricoh Corporation bears no responsibility for incidental damages (lost profit, work interruption, corruption or loss of the memory contents, etc.) arising from the use of or the inability to use this unit.
- Ricoh Corporation accepts no liability whatsoever for any damages arising from not having followed the descriptions in this Owner's Manual.
- Ricoh Corporation accepts no liability whatsoever for any damages arising from malfunctions arising from combination with equipment or software that is not related to Ricoh Corporation.
- Ricoh bears no responsibility for information being intercepted or leaked due to the use of a wireless LAN, or any damages therefore.

OTHER INFORMATION

Copyrights

Showing or transmitting commercial imaging software or broadcast or cable-broad casting programs with the purpose of other than the personal and private viewing, including modifying images using the freeze or resize functions, or displaying with the varying aspect ratio of the images, could violate the direct or indirect copyrights of the imaging software or broadcast program, etc., if done without first consulting with the copyright holder. For this reason, please take appropriate measures including obtaining a license from the copyright holder, before performing one of the actions listed above.

Disposal

This product contains substances which are harmful to humans and the environment.

- The lamp contains mercury.

Please dispose of this product or used lamps in accordance with local regulations.

Following information is only for EU-member states:

The use of the symbol indicates that this product may not be treated as household waste. By ensuring this product is disposed of correctly, you will help prevent potential negative consequences for the environment and human health, which could otherwise be caused by inappropriate waste handling of this product. For more detailed information about recycling of this product, please contact your local city office, your household waste disposal service or the shop where you purchased the product.



OTHER INFORMATION (Continued)

Trademarks

- VGA, SVGA, XGA, SXGA, UXGA and WXGA are trademarks or registered trademarks of International Business Machines Corporation.
- Mac is a registered trademark of Apple Computer, Inc.
- Microsoft, Windows, Windows 2000, Windows XP, Windows Vista, Windows 7 and PowerPoint are registered trademarks or trademarks of Microsoft Corporation in the U.S. and other countries.
- Adobe and Acrobat Reader are registered trademarks of Adobe Systems Incorporated.
- Contains technology by Saskaen, Inc.
Copyright © 2000-2010 Saskaen, Inc. All rights reserved.
- All other brand and product names are trademarks or registered trademarks of their respective companies.
- HDMI, the HDMI logo and High-Definition Multimedia Interface are trademarks or registered trademarks of HDMI licensing LLC.

Notational Conventions Used in This Manual

- References to pages with related information are annotated as follows.
For example, if making a reference to page 36: [p.36](#)
- The illustrations in this document are for reference purposes only and may not reflect your package exactly.

REMOTE CONTROL BATTERIES

Warning

- Never throw batteries into a fire.

Using the batteries improperly may cause them to explode or leak and may result in serious injury. If battery-leaking fluid contacts skin, wash the fluid off immediately with clean water and consult a doctor. If the fluid spills on an instrument, avoid contact and wipe it off using tissue paper. Then dispose of the used tissue paper as flammable garbage after moistening the tissue with water.

Notes

- Be sure to use AAA (LR03) size batteries.
- Dispose of batteries in a designated disposal area.
- Attention should be drawn to the environmental aspects of battery disposal.
- Do not mix different battery types or combine used batteries with new ones.
- If the remote control does not operate correctly, or if the operating range becomes reduced, replace both batteries with new ones.
- If the batteries are dead or if you will not be using the remote control for a long time, remove the batteries to prevent battery acid from leaking into the battery compartment.
- **Following information is only for EU-member states:**

[Disposal of batteries and/or accumulators]

The crossed out wheeled dust bin symbol indicates that batteries and/or accumulators must be collected and disposed of separately from household waste.

If the battery or accumulator contains more than the specified values of lead (Pb), mercury (Hg), and/or cadmium (Cd) defined in the Battery Directive (2006/66/EC), then the chemical symbols for lead (Pb), mercury (Hg) and/or cadmium (Cd) will appear below the crossed out wheeled dust bin symbol.

By participating in separate collection of batteries, you will help to assure the proper disposal of products and batteries and thus help to prevent potential negative consequences for the environment and human health.

For more detailed information about the collection and recycling programmes available in your country, please contact your local city office or the shop where you purchased the product.



CONTENTS

Before Using

SAFETY PRECAUTIONS	2
IMPORTANT SAFETY INSTRUCTIONS	4
POWER SUPPLY INFORMATION	9
IMPORTANT PRECAUTIONS	9
EXEMPTION CLAUSES	10
OTHER INFORMATION	10
REMOTE CONTROL BATTERIES	11
CONTENTS	12

Preparations

Checking the package contents	14
Names of each part on the main unit	15
Names of each part on the control panel and remote control	16
Names of the terminals on the rear panel	18
Preparing and using the remote control	19
Operating a computer using the remote control	20
Placement	21
Connection	24

Operations

Turning the power on and off	26
Basic operations	28
Using handy features	31
Using auto setting (For computer input only)	31
Correcting the keystone distortion	31
Resizing image	32
Cutting off the picture and sound temporarily (Mute)	33
Changing picture mode	33
Changing screen size	33
Freezing the image (Freeze)	34
Setting the password	34
Using the menus 1	36
Setup using the Setting display	36
The image adjustment menu	37
The display setting menu	39
The default setting menu	42
Displaying Information (Status display)	45

Network/USB memory

Before connecting via a network	46
How to use the USB terminal	48
Using the menus 2	50
Setup using the Setting display (2)	50
Setting up the Network Projector/Network Utility	51
Computer settings	56
The control setting menu	57
Setting slideshow options	58
Checking the projector status	60
Status display	60
Using the Network Projector	61
Installing the applications	62
Using the Network Utility	64
Displaying a computer's screen via the projector	64
Displaying a JPEG image saved on a computer via the projector	66
Displaying a video file saved on a computer via the projector	67
Displaying computer's screens via projectors using the Multiscreen function	70
Easy Connect utility	75
Operating the projector	79
Projecting images stored in a USB memory device	80
Playing a slide show from a thumbnail list	80
How to use the JPEG Conversion Tool	83
Launching the JPEG Conversion Tool	83
Converting an image file	83
Converting files created with Microsoft® PowerPoint®	84
Making a presentation with converted JPEG files	85
Creating a screen capture and converting it into a JPEG file	86
Setting up the projector using a Web browser	87

Maintenance

Lamp replacement	91
Air filter cleaning	94
Lens and main unit cleaning	95

Others

Trouble indications	96
Troubleshooting	97
Specifications	99

Checking the package contents

Please make sure that the following items are included in the box, along with the main unit. If any item is missing, immediately contact the store where you purchased the product.

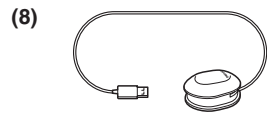
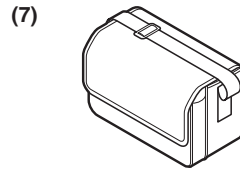
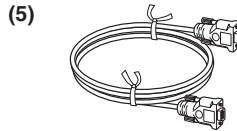
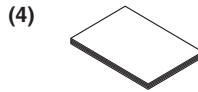
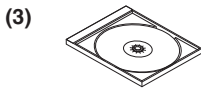

- (1) Remote control
- (2) LR03 (SIZE AAA) batteries for remote control (2)
- (3) CD-ROM
- (4) Owner's Manual
- (5) RGB cable (3 m) ^[Note 1]
- (6) Power cord ^[Note 1, 2]
- (7) Carrying bag
- (8) Mouse remote control receiver

Notes

- 1: To maintain original performance, always use the supplied cables.
- 2: The shape and number of supplied power cords vary depending on the product destination.

Save Original Packing Materials

The original shipping carton and packing materials will come in handy if you ever have to ship your projector. For maximum protection when shipping your projector, repack the set as it was originally packed at the factory.

◆The Supplied CD-ROM

The supplied CD-ROM contains an owner's manual which includes information not available for the printed Owner's manual (Getting started) and Projector Management Utility Manual in Portable Document Format (PDF) in addition to each application software. Please use **Acrobat Reader 5** or later version to view the manual.

■ Adobe® Acrobat® Reader® or Adobe® Reader®

The supplied CD-ROM does not contain **Acrobat® Reader®**. If you cannot read PDF files, please install **Acrobat Reader** software in your computer by downloading it from the Adobe Systems website.

■ Viewing the manual

Double-click the PDF file in the folder with the name of a language on the CD-ROM. Acrobat® Reader® launches, and the Owner's Manual cover and list of bookmarks appear. Click a bookmark title to view that section of the manual. Click  to view a reference page with related information. See the Help menu for more information about Acrobat® Reader®.

Names of each part on the main unit

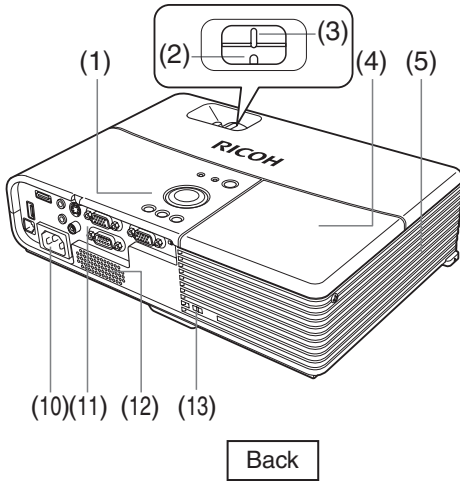

Back

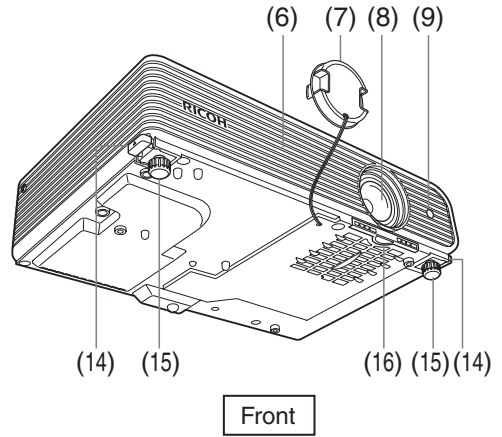

Front

Preparations

Name	: Function
(1) Control panel	: Operates the projector. p.16
(2) Zooming lever	: Adjusts screen size. p.29
(3) Focusing lever	: Adjusts screen focus. p.29
(4) Lamp cover	: Remove to replace lamp. p.92
(5) Air exhaust	: Expels air that has grown hot inside the projector.
(6) Air intake	: Draws in air from outside the projector for internal cool down.
(7) Lens cap	: Replace the cap when not using the projector to protect the lens.
(8) Lens	: Projects expanded image.
(9) Infrared remote sensor	: Senses commands from the remote control. p.19
(10) AC IN socket	: Connects the supplied power cord here.
(11) Terminals on the rear panel	: Connects external devices. p.18
(12) Speaker	: Outputs audio sound.
(13) Antitheft lock slot	: Attach a safety cable or any other antitheft device.
(14) Foot adjuster release button	: Press to set up or stow the foot adjuster. p.29
(15) Foot adjuster	: Adjusts the vertical projection angle. p.29
(16) Air filter	: Prevents dirt and dust from getting into the inside of the projector. p.94

Names of each part on the control panel and remote control

Control panel

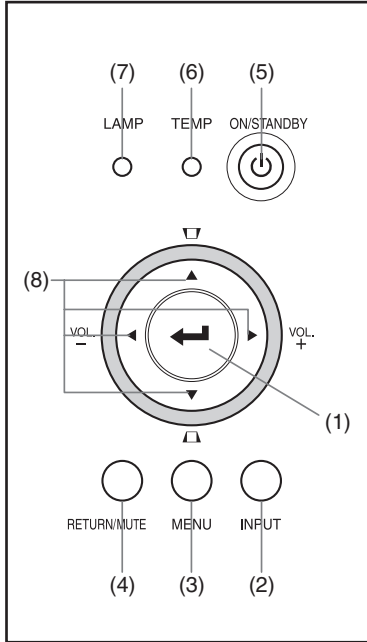

Remote Control

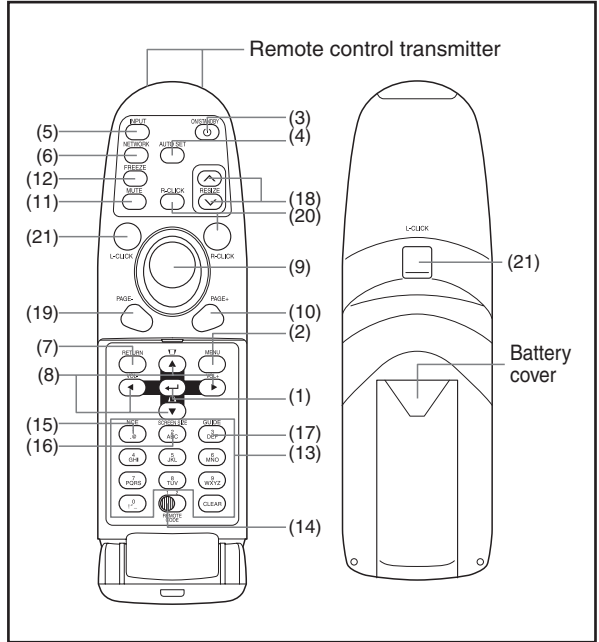

Name : Main Function

Control panel

- (1) ENTER button : Accepts the selected mode.
- (2) INPUT button : Selects input. [p.28](#)
- (3) MENU button : Displays menus. [p.36](#)
- (4) RETURN/MUTE button : Goes back one screen. Also, cuts off the picture and sound temporarily. [p.33](#)
- (5) ON/STANDBY button/ ON/STANDBY indicator : Turns the power on/off (standby). [p.26](#)
: Displays whether power is on or off (standby). [p.26](#)
- (6) TEMP indicator : Lights when internal temperature is too high. [p.96](#)
- (7) LAMP indicator : Displays lamp mode. [p.96](#)
- (8) Selection button : Menu selections and adjustments, volume control and keystone adjustment, etc. [p.36](#)

Remote control

- (1) ENTER button : Accepts the selected mode.
- (2) MENU button : Displays menus. [p.36](#)
- (3) ON/STANDBY button : Turns the power on/off (standby). [p.26](#)
- (4) AUTO SET button : Performs auto-adjustment of input signals from computer. [p.31](#)
- (5) INPUT button : Selects input. [p.28](#)
- (6) NETWORK button : Switches to network input mode. [p.50](#)

Name	Main Function
(7) RETURN button	: Goes back one screen.
(8) Selection button	: Menu selections and adjustments, volume control and keystone adjustment, etc. p.36
(9) Mouse control button	: Controls a mouse pointer. p.20 p.65 p.71
(10) PAGE+ button	: Proceeds PowerPoint® slides. p.20 p.65 p.71
(11) MUTE button	: Cuts off the picture and sound temporarily. p.33
(12) FREEZE button	: Pauses image. p.34
(13) Ten-Key button	: Use as a ten-key pad with wireless LAN, from which numbers and characters can be entered. p.52
(14) Remote control code switch	: Sets the code of remote control to that of the projector. p.44
(15) NCE button	: Changes picture mode. p.33
(16) SCREEN SIZE button	: Changes screen size. p.33
(17) GUIDE button	: Displays operation guide for slideshow. p.82
(18) RESIZE button	: Enlarges image. p.32
(19) PAGE- button	: Goes back PowerPoint® slides. p.20 p.65 p.71
(20) R-CLICK button	: Functions as right-click of a mouse. There are two R-CLICK buttons. Either is usable. p.20 p.65 p.71
(21) L-CLICK button	: Functions as left-click of a mouse. There are two L-CLICK buttons. Either is usable. p.20 p.65 p.71

Note

- For the remainder of this manual, buttons are referred to as follows:

Selection buttons ⇒     ; ENTER button ⇒ 

Names of the terminals on the rear panel

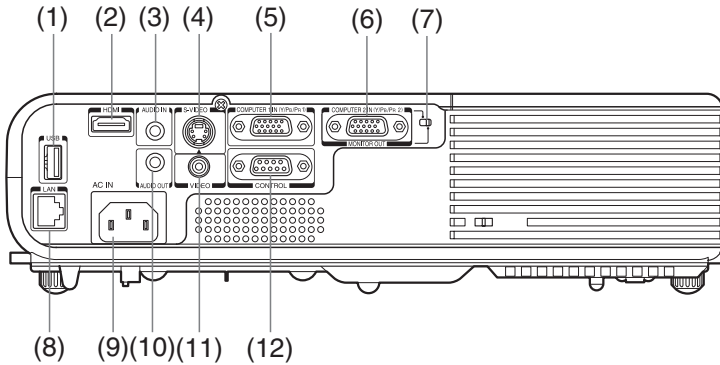

Name	Main Function
(1) USB terminal	: Connects a commercial USB memory device. p.48
(2) HDMI™ terminal	: Inputs digital signals from HDMI (High-Definition Multimedia Interface) compatible digital source.
(3) AUDIO IN terminal	: Inputs audio signals from a computer or video equipment. (Multiple use for COMPUTER 1 IN/2 IN, VIDEO and S-VIDEO)
(4) S-VIDEO terminal	: Inputs S video signals from video equipment.
(5) COMPUTER 1 IN (Y/P _B /P _R 1) terminal	: Inputs analog RGB signal from a computer or a component video signal (Y/P _B /P _R) from video equipment.
(6) COMPUTER 2 IN (Y/P _B /P _R 2) terminal/MONITOR OUT terminal	: Inputs analog RGB signal from a computer or a component video signal (Y/P _B /P _R) from video equipment. It can also be used as MONITOR OUT terminal by the switch of (7).
(7) Switch	: Switches between COMPUTER 2 IN and MONITOR OUT.
(8) LAN terminal	: Connects a network cable.
(9) AC IN socket	: Connects the supplied power cord here.
(10) AUDIO OUT terminal	: Outputs audio signals.
(11) VIDEO terminal	: Inputs video signals from video equipment.
(12) CONTROL terminal	: When operating the projector via a computer, connect this to the controlling computer's RS-232C port. p.103

Preparing and using the remote control

■ Loading dry-cell batteries into the remote control

- ① Remove the battery cover.

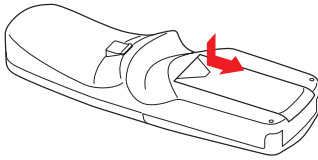

- ② Insert the dry-cell batteries. Be sure to align the plus and minus ends of the batteries properly.

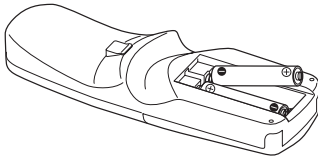

Two batteries (LR03, SIZE AAA) are used.

- ③ Replace the battery cover.

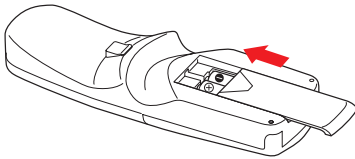

■ Dry-cell batteries

- Before using the batteries, be sure to observe the Safety Precautions described in previous pages.
- Remove batteries from remote control when not using for extended periods.
- If the remote control stops working, or if its range decreases, replace all the batteries with new ones. (2 batteries (LR03 SIZE AAA))
- Keep the batteries away from the reach of children.
Batteries are choking hazards and can be very dangerous if swallowed. If the batteries are swallowed, seek medical assistance immediately.

■ The remote control

- The remote control may fail to operate if the infrared remote sensor is exposed to bright sunlight or fluorescent lighting.
- Do not drop or bang.
- Do not leave in hot or humid locations.
- Do not allow it to get wet or place it on top of wet objects.
- Do not take it apart.
- In rare cases, ambient conditions could impede the operation of the remote control. If this happens, point the remote control at the main unit again, and repeat the operation.

■ Operating the remote control

Point toward the projector's infrared remote sensor, and press any button on the remote control.

- Operating the projector from the front

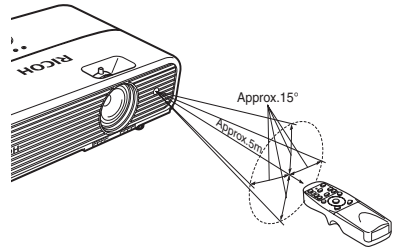

Note:

When operating the remote control from behind the projector, the infrared signal is reflected on the projecting surface. The operating range therefore may decrease depending on the shape and material of the projecting surface.

Operating a computer using the remote control

A computer can be operated using the projector's remote control. This function is available on any computer with the Windows® 2000, Windows® XP, Windows Vista®, or Windows® 7 operating system, that is equipped with a USB port which can support USB 2.0 (The mouse remote control receiver is also supported on Mac OS X for the Mac). However, please note that Ricoh does not guarantee the operation of all computers.

1 Connecting a computer

Connect the mouse remote control receiver (supplied) to a computer.

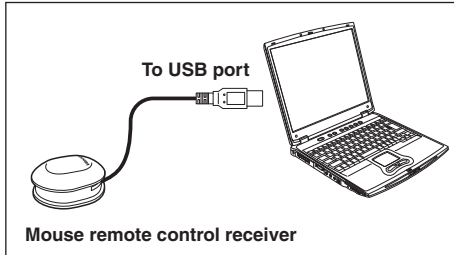

The remote control may fail to operate if the mouse remote control receiver is exposed to bright sunlight or fluorescent lighting.

In such a case, change position or direction of the mouse remote control receiver and retry.

2 Operating a computer

Operate remote control's buttons towards the mouse remote control receiver.

● Moving the mouse pointer

Press the mouse control button in the direction you wish the mouse pointer to move.

● To left click

Press the L-CLICK button (There are two L-CLICK buttons. Either is usable).

● To right click

Press the R-CLICK button (There are two R-CLICK buttons. Either is usable).

● To drag and drop

Holding down the L-CLICK button, move the mouse control button until the mouse pointer is over the desired location, then release the L-CLICK button.

● Using the computer's page up [↑] and down [↓] function

Press the PAGE+ and PAGE- buttons to switch PowerPoint® slides.

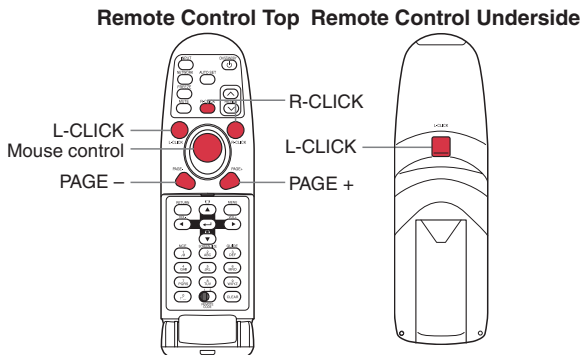

Placement

Placement Styles

As shown in the figures below, this device can be placed in 4 different styles. The factory setting is “floor-mounted front projection.” Set the [Projection mode] in the Default setting 2 menu [p.43](#), in accordance with your needs.

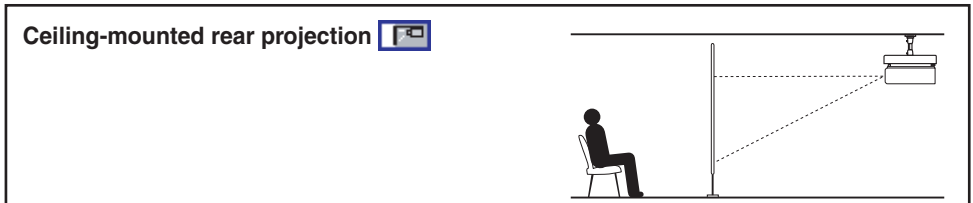
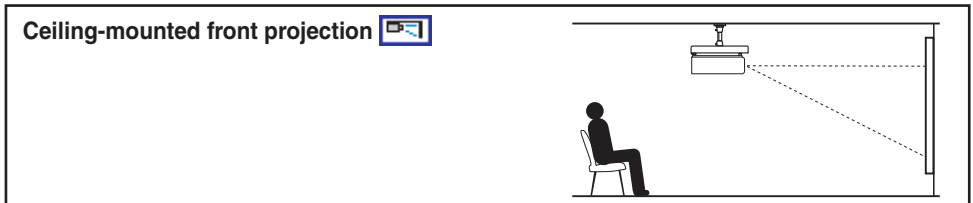
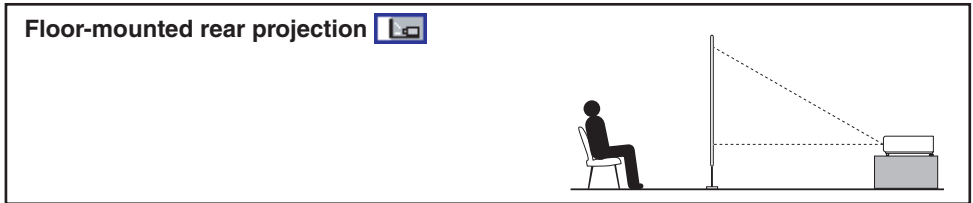
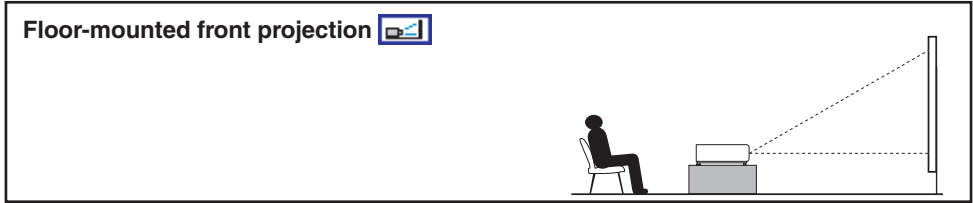

WARNING

- **Always obey the instructions listed in IMPORTANT SAFETY INSTRUCTIONS when placing the unit.** Attempting to clean and replace the lamp in a high location by yourself may cause you to fall, resulting in injury.
- **If you wish to mount the projector on the ceiling, be sure to ask your sales representative before doing so.** Mounting the projector on a ceiling requires special ceiling brackets (sold separately) and specialized knowledge. Improper mounting could cause the projector to fall, possibly resulting in injury and damage, to the unit.
- **If the projector is ceiling-mounted, install the breaker for turning off the power in case of anomaly.** Let everyone involved with the use of the projector know that fact.

Placement (Continued)

Projection Distance and Size

Use the figures, tables, and formulas below to determine the projection size and projection distance. (Projection sizes are approximate values for full-size picture with no keystone adjustment.)

PJ X3241N

$$a \text{ (min length)} = \frac{\text{Projection size (inches)} - 0.890}{32.863}$$

$$a \text{ (max length)} = \frac{\text{Projection size (inches)} - 0.748}{27.363}$$

Screen

As seen from above

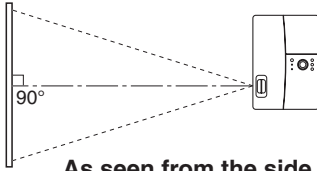

As seen from the side

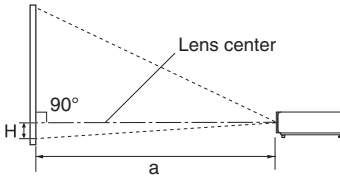

Projection size	Projection distance a		Height (H)
	min length (zooming max)	max length (zooming min)	
30 inches	0.89 m (2.92 ft.)	1.07 m (3.51 ft.)	6.50 cm (0.21 ft.)
40 inches	1.19 m (3.90 ft.)	1.44 m (4.72 ft.)	8.70 cm (0.29 ft.)
50 inches	1.49 m (4.89 ft.)	1.80 m (5.91 ft.)	10.90 cm (0.36 ft.)
60 inches	1.80 m (5.91 ft.)	2.17 m (7.12 ft.)	13.10 cm (0.43 ft.)
70 inches	2.10 m (6.89 ft.)	2.53 m (8.30 ft.)	15.20 cm (0.50 ft.)
80 inches	2.41 m (7.91 ft.)	2.90 m (9.51 ft.)	17.40 cm (0.57 ft.)
90 inches	2.71 m (8.89 ft.)	3.26 m (10.70 ft.)	19.60 cm (0.64 ft.)
100 inches	3.02 m (9.91 ft.)	3.63 m (11.91 ft.)	21.80 cm (0.72 ft.)
120 inches	3.62 m (11.88 ft.)	4.36 m (14.30 ft.)	26.10 cm (0.86 ft.)
150 inches	4.54 m (14.90 ft.)	5.46 m (17.91 ft.)	32.70 cm (1.07 ft.)
200 inches	6.06 m (19.88 ft.)	7.28 m (23.88 ft.)	43.50 cm (1.43 ft.)
250 inches	7.58 m (24.87 ft.)	9.11 m (29.89 ft.)	54.40 cm (1.78 ft.)
300 inches	9.10 m (29.86 ft.)	10.94 m (35.89 ft.)	65.30 cm (2.14 ft.)

a is the distance (m, feet) between the lens and the screen, and corresponds to a range of 0.89 m (2.92 ft.) to 10.94 m (35.89 ft.). **H** is the height from the image bottom to the center of the lens.

PJ WX3231N

Screen

As seen from above

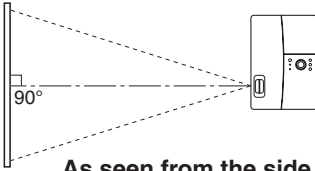

As seen from the side

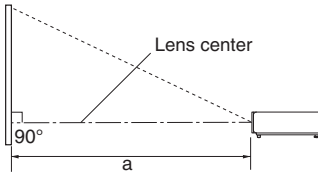

$$a \text{ (min length)} = \frac{\text{Projection size (inches)} - 0.758}{31.022}$$

$$a \text{ (max length)} = \frac{\text{Projection size (inches)} - 0.643}{25.845}$$

Projection size	Projection distance a	
	min length (zooming max)	max length (zooming min)
30 inches	0.94 m (3.08 ft.)	1.14 m (3.74 ft.)
40 inches	1.27 m (4.17 ft.)	1.52 m (4.99 ft.)
50 inches	1.59 m (5.22 ft.)	1.91 m (6.27 ft.)
60 inches	1.91 m (6.27 ft.)	2.30 m (7.55 ft.)
70 inches	2.23 m (7.32 ft.)	2.68 m (8.79 ft.)
80 inches	2.55 m (8.37 ft.)	3.07 m (10.07 ft.)
90 inches	2.88 m (9.45 ft.)	3.46 m (11.35 ft.)
100 inches	3.20 m (10.50 ft.)	3.84 m (12.60 ft.)
120 inches	3.84 m (12.60 ft.)	4.62 m (15.16 ft.)
150 inches	4.81 m (15.78 ft.)	5.78 m (18.96 ft.)
200 inches	6.42 m (21.06 ft.)	7.71 m (25.30 ft.)
250 inches	8.03 m (26.35 ft.)	9.65 m (31.66 ft.)
300 inches	9.65 m (31.66 ft.)	11.58 m (37.99 ft.)

a is the distance (m, feet) between the lens and the screen, and corresponds to a range of 0.94 m (3.08 ft.) to 11.58 m (37.99 ft.).

The lens center is in the same level with an image bottom.

Connection

Before connection

- Read the owner's manual of the device you are connecting to the projector.
- Some computers cannot be used with or connected to this projector.
Check for an RGB and an HDMI output terminal, supported signal [p.100](#) [p.101](#), etc.
- Turn off the power of both devices before connecting.
- The figure below shows sample connections. This does not mean that all of these devices can or must be connected simultaneously. (Dotted lines mean items can be exchanged.)

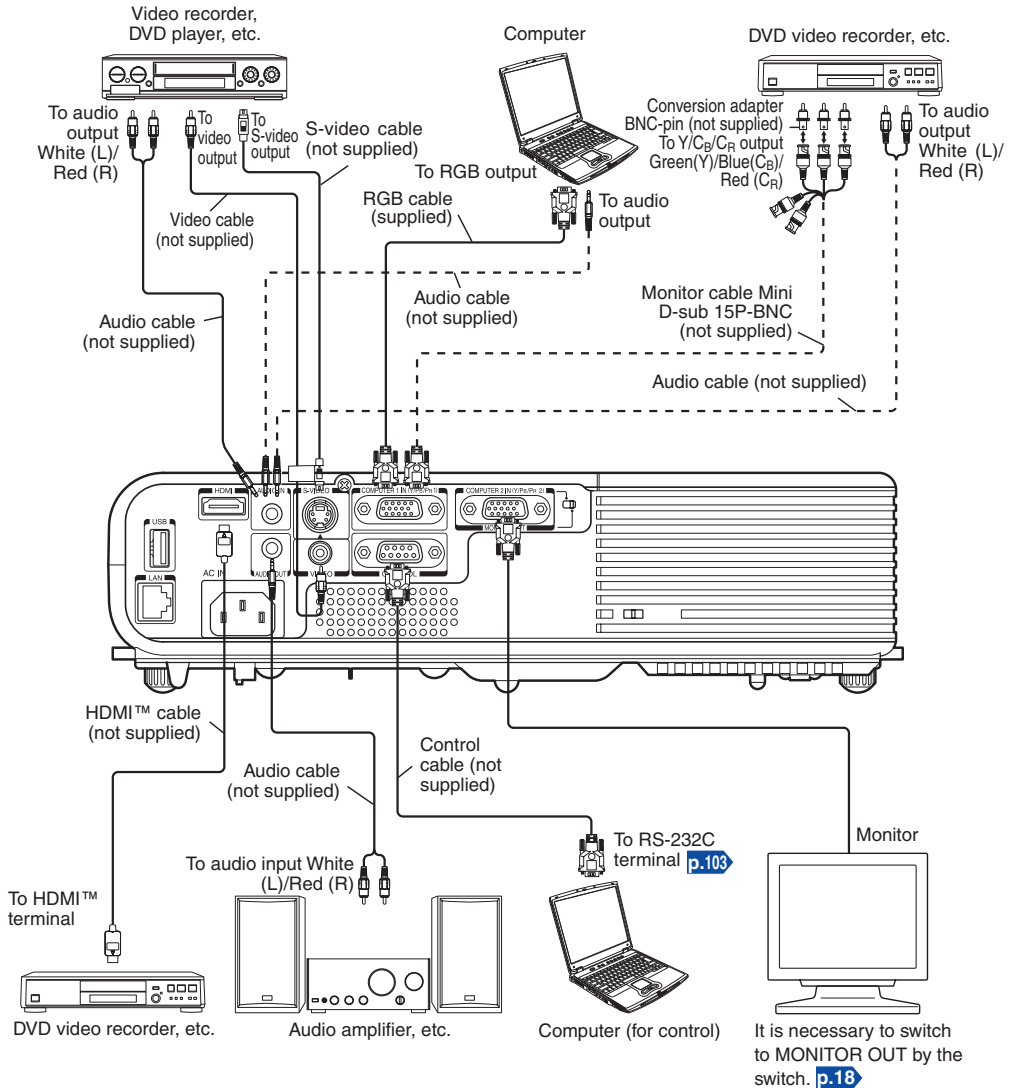

* The connection for COMPUTER 1 IN terminal described here is also applicable for COMPUTER 2 IN terminal.

Notes

- When COMPUTER 2 IN terminal is used as MONITOR OUT terminal, the signal which is input to COMPUTER 1 IN terminal is output.
- Signals are output from MONITOR OUT terminal even in standby mode. However, from AUDIO OUT terminal, no audio signal is output.
- A computer monitor cannot accept Y/P_B/P_R signals correctly.
- The AUDIO IN terminal can be used for devices connected to COMPUTER 1 IN terminal, COMPUTER 2 IN terminal, VIDEO terminal and S-VIDEO terminal.
- When an AUDIO OUT terminal is connected, sound is not output from the projector speaker.
- Output volume of AUDIO OUT terminal can be adjusted by the **VOL** button.
- Some devices may not operate properly when connecting with HDMI™.
- For optimal performance, it is recommended that you use an HDMI™ cable with the HDMI Logo (**HDMI**). To display a 1080p signal format, you will need a High Speed HDMI™ cable. A conventional HDMI™ cable may not work properly.
- When connecting a network cable, use a shielded cable.

Turning the power on and off

■ Connect the power cord

- 1 Insert the power cord connector into the AC IN socket of the projector.
- 2 Insert the power cord plug into a wall or other power outlet.

The ON/STANDBY indicator flashes green and the projector enters standby mode.
When [Network standby] is set to [On], the ON/STANDBY indicator lights orange.

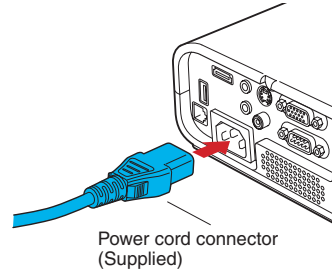

■ Turn the power on

- 1 Remove the lens cap.

Be sure to remove the lens cap when the power is turned on. If the cap is left on the projector, it could become deformed due to heat.

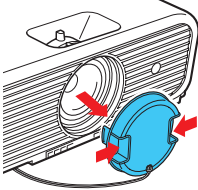

- 2 Press the ON/STANDBY button.

The power turns on with a beep sound (if the beep sound is set to [On]), and the ON/STANDBY indicator flashes orange, and then flashes green. When [Network standby] is set to [On], the ON/STANDBY indicator flashes green. After a moment, the start-up screen appears.

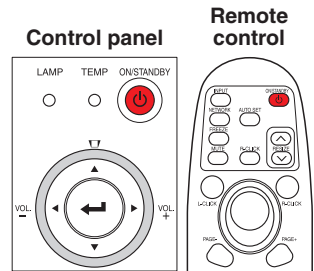

⚠ CAUTION

- Do not look into the lens while the lamp is on. The strong light from the lamp may cause damage to your eyesight.
- Do not block the air intake or exhaust. Doing so could cause a fire due to internal overheating.
- Do not place your hands, face, or other objects near the air exhaust, the lamp cover or the bottom of the unit. Doing so could result in injury and/or damage the object.

■ Notes

- The start-up screen will disappear after a moment. You can also configure the system to prevent the start-up screen from appearing. To do this, use the **Display setting** menu [p.39](#).
- The first time you use the projector after purchase, after the start-up screen disappears, the start menu is displayed [p.28](#).
- You can disable the beep sound in the **Default setting 1** menu [p.42](#).
- When [Key lock] is [On], the operation buttons of the projector do not work [p.43](#).
- When [Password] is [On], enter password then the start-up screen is displayed after the Password entry screen disappears [p.35](#).
- Do not touch the lens directly with your hand.
If fingerprints or stains are left on the projection lens surface, they may interfere with the projector's ability to project images on the screen.

■ Turn the power off

① Press the ON/STANDBY button.

When the beep sound setting is [On], the projector beeps, and a message appears, confirming that you wish to shut off the power. To shut off the power, press the ON/STANDBY button again. If you do not wish to shut off the power, wait for a while without conducting any operations. The message will disappear after a moment and the operation will no longer be valid.

② Press the ON/STANDBY button again.

When the beep sound setting is [On], the projector beeps, and the screen disappears, but the internal cooling fan continues to operate. The projector will then go into standby mode. During cooling, the ON/STANDBY indicator flashes. While the indicator is flashing, the power cannot be turned back on. There is no problem with unplugging the power cord in this state.

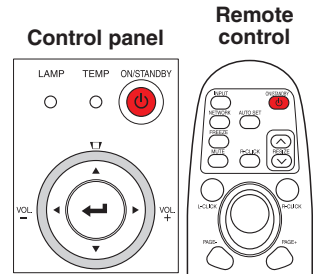

③ Replace the lens cap.

After use, replace the lens cap.

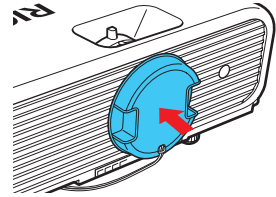

■ Note

- The projector consumes about 4.5 W of power in standby. We recommend that you unplug the power cord if you will not be using the projector for an extended period. When [Network standby] is [On], it consumes about 8 W during standby.

■ Precautions

- If you wish to restart the projector again right after turning off the power, give the lamp time (about 5 minutes) to cool before plugging it back in. If the lamp overheats, it may fail to light.
- Right after turning off the power, the unit may become very hot, especially the air exhaust, lamp cover or bottom of the unit. Please handle with care to avoid burn injuries.

Basic operations

① Turn on the power.

Turn on the power by following the instructions in “Turn the power on” [p.26](#).

② Select the language and the lamp power during initial startup.

When the projector is used for the first time after purchase, the start menu for language selection, lamp power selection and configuration is displayed in English. (If the screen is out of focus, adjust it according to the step [⑥](#).)

① Use the , , or button to select the desired language and then press the button.

English	English
Français	French
Deutsch	German
Italiano	Italian
Español	Spanish
Português	Portuguese
Русский	Russian
Svenska	Swedish
Türkçe	Turkish

Polski	Polish
Norsk	Norwegian
Suomi	Finnish
Čeština	Czech
Magyar	Hungarian
Ελληνικά	Greek
Dansk	Danish
Nederlands	Dutch
Română	Rumanian

日本語	Japanese
中文(简体字)	Chinese (simplified)
中文(繁體字)	Chinese (traditional)
한국어	Korean
Indonesia	Indonesian
ภาษาไทย	Thai
العربية اللغة	Arabic

The message for setup confirmation is displayed in the selected language. Then, the menu for lamp power selection and configuration is displayed. It is automatically set as Standard. To change the setting, follow the step [②](#).

② Use the , button to select the lamp power and press the button.

The lamp power, if selected, will be toggled without pressing the  button. The display automatically disappears in a few seconds.

■ Notes

- When the projector is turned on the next time, the start menu will not appear upon startup. However, if [Reset all] is executed from the **Default setting 2** menu [p.43](#), the start menu will be displayed the next time the power is turned on.
- The language can also be set via the **Display setting** menu [p.39](#) and Lamp power via the **Default setting 1** menu [p.42](#).
- This owner's manual assumes that English has been selected.

③ Activate the connected device.

Turn on and start the connected device such as a computer.

④ Press the INPUT button.

An image of the connected equipment is projected.

Each time you press the **INPUT** button, it switches to the input of the connected equipment that is outputting video signals.

Notes

- When [Auto input search] is set to [Off] in the **Default setting 1** menu [p.42](#), the **Input select** menu appears if you press the **INPUT** button. The factory default setting is [On].
- If the projector is in network input mode and no image is projected after you press the **INPUT** button, check that the connected equipment is working, and press the **INPUT** button again.
- If no signal is being output from the connected equipment, pressing the **INPUT** button does not change the input and “**There is no other input signal.**” message will appear.

5 Adjust projector placement angle.

You can adjust the placement angle and the height of the projected image using the foot adjuster.

① Lift up the front of the projector to the desired angle, then press the foot adjuster release button upward.

The foot adjuster extends. Release the button to lock the position.

② To fine adjust the angle, twist the foot adjuster.

- To stow the foot adjuster, hold up the projector while pressing the foot adjuster release button, then slowly lower the projector.

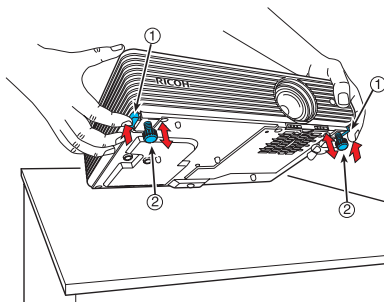

Note

- When [Auto keystone] is set to [On] in the **Default setting 1** menu, the keystone distortion will automatically be corrected based on the projector placement angle. If you do not desire the automatic keystone correction, set [Auto keystone] to [Off].

6 Adjust the screen size and focus.

① Use the zooming lever to adjust the screen size.

② Use the focusing lever to adjust the focus.

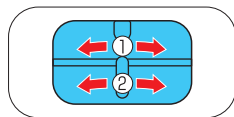

Front

7 Adjust the volume with the ◀ ▶ buttons.

The speaker volume can be adjusted when an audio signal is being input.

Basic operations (Continued)

■ Precautions

- Lamp characteristics may rarely cause the brightness to fluctuate slightly.
- The LCD panel is manufactured using high precision technology. There may be black spots (pixels that do not light) or bright spots (pixels that are constantly lit) on the panel. These are intrinsic characteristics of the manufacturing technology and are not malfunctions.

■ Notes

- A lamp is a consumable item. If used for extended periods, images will appear dark, and the lamp could burn out. This is characteristic of a lamp, and is not malfunction. The lifetime of the lamp depends on conditions of use.
- Although this projector supports a wide range of RGB signals [p.100](#), any resolutions not supported by this projector (XGA for X3241N, WXGA for WX3231N) will be expanded or shrunk, which will slightly affect image quality. To view high-quality images, set the computer's external output to XGA for X3241N, WXGA for WX3231N.
- With some computer models having LCD or similar displays, displaying images simultaneously on the projector and the monitor's display may prevent the images from displaying properly. If this happens, turn off the computer's LCD display. For information on how to turn off the LCD display, see the computer's owner's manual.
- A **"No signal"** message will appear if no signal is being input from the connected equipment or if signal input is stopped while projecting.
- If a signal not supported by the projector is input, the **"Unsupported signal"** message will appear.
- If an unavailable operation button is pressed, the  icon will appear with a beep sound (if the beep sound is set to **[On]**).
- Moving pictures played back on computers using DVD software may appear unnatural when projected with this projector. However, it is not a malfunction of the projector.

■ LCD Panels

LCD panels wear out. In order to prolong the lifetime of your LCD panel, take the following precautions:

- To extend the lifetime of the LCD panel, always turn off the power when it is not in use, and make sure that the lamp is off. Keeping the lamp off will also save electricity.
- If the air filter becomes dirty and clogged, the projector's internal temperature will rise, shortening the lifetime of the LCD panel and causing malfunctions. We recommend regular and thorough cleaning of the air filter [p.94](#).
- If the air filter becomes damaged, replace it. Contact your sales representative for a new filter. If you continue to use the projector when its filter is damaged, dust and dirt will enter the interior and this could cause the projector to stop working or break down.

Using handy features

■ Using auto setting (For computer input only)

This function automatically sets up the projector to the optimum state. It sets up the sampling phase, frequency and screen position, etc., for each type of input signal through a simple operation.

● Press the remote control's AUTO SET button.

The  icon will appear during processing.

You can also set it by selecting **[Auto setting]** in the **Image adjustment** menu [p.37](#).

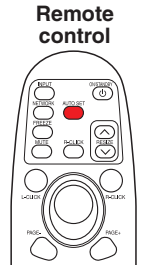

■ Notes

- The image may not be projected or auto adjustment/setting may not be performed correctly for input signals other than those supported by the projector [p.100](#), [p.101](#).
- If auto setting fails adjustment, adjust it manually with **[Position]** in the **Image adjustment** menu [p.38](#).



■ Correcting the keystone distortion

When the projector placement angle toward the screen is changed while projecting the image, the picture will undergo keystone (trapezoidal) distortion.

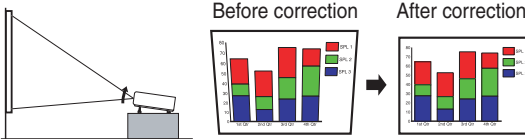
This projector is capable of automatically correcting this keystone distortion based on the projector's placement angle.



● Adjusting Keystone distortion Manually

Use the   buttons for manual keystone adjustment.

■ Notes

- Depending on the amount of keystone adjustment needed and the image content, some information may be lost, or the picture quality may suffer.
- Even if **[Auto keystone]** is set to **[On]**, keystone distortion can be adjusted manually. Note that if you change the position or angle of the projector, automatic keystone correction will be performed again.
- When **[Auto keystone]** is set to **[On]**, the automatic keystone correction will be performed each time the power is turned on.
- Since keystone correction settings are memorized after the power has been turned off, it is recommended that you first set **[Auto keystone]** to **[Off]**. Then if the projector placement angle against the screen remains unchanged, the keystone adjustment will also remain unchanged.

Control panel

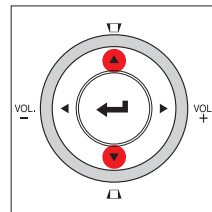

Remote control

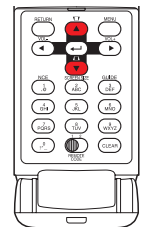

Using handy features (Continued)

■ Resizing image

The projected image can be resized (zoomed in/out).

① Press the remote control's RESIZE button.

Each time you press the RESIZE  button, zoom ratio is up. You can keep pressing it to enlarge the image further.

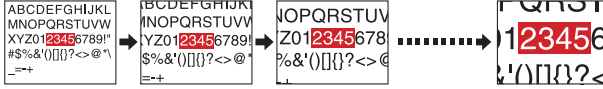

② To zoom out, press the remote control's RESIZE button.

Each time you press the RESIZE  button, zoom ratio is down. You can keep pressing it to reduce the image further. (However, the image cannot be smaller than the original size.)



③ To move the area to zoom in, use the buttons.

You can keep pressing the button until reaching the desired area.



④ When the image returns to the original size by pressing RESIZE button several times, the zoom will be reset.

Pressing the RETURN button during resizing also resets the zoom.

■ Notes

- The  icon appears while resizing.
- Operating a function other than Mute will release resizing.
- As zooming is processed digitally, the image quality is degraded in larger zoom ratio.
- During resizing or moving the zooming area, the image may be distorted.

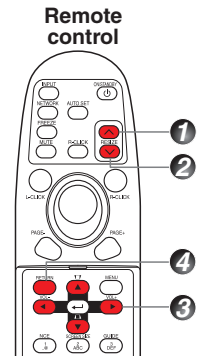

■ Cutting off the picture and sound temporarily (Mute)

When you want to project the images of another projector or overhead projector temporarily, this projector's images and sound can be turned off using the **MUTE** button.

- **Press the remote control's MUTE button or the RETURN/MUTE button on the projector control panel.**

The picture and sound are cut off. (Pressing the **MUTE** button or the **RETURN/MUTE** button again cancels the Mute function and restores the picture and sound.)

The **RETURN/MUTE** button on the control panel cannot be used for muting in the following situations:

- The projected image is resized.
- A menu is displayed.
- USB memory-input is selected.
- Network input mode is selected and no signal is input through the network.

■ Notes

- The  icon will appear while mute is in effect.
- Operating any other function will also cancel the muting.

■ Changing picture mode

The projected image mode can be selected using the **NCE** button.

- **Press the remote control's NCE button and select with the   buttons.**

After selection, apply it by pressing the  button.

- For computer, HDMI, USB memory and Network-input images, the following settings are available.

Dynamic/Standard/Photographic

- For Y/P_B/P_R, Video and S-video-input images, the following settings are available.

Vivid/Standard/Cinema

■ Note

- You can also change the picture mode using [**NCE**] of the **Image adjustment** menu [p.37](#).

■ Changing screen size

The screen size for the projected image can be changed using the **SCREEN SIZE** button.

- **Press the remote control's SCREEN SIZE button.**

Pressing the button switches in turn as follows:

X3241N : **Normal/Full/Thru/Wide**

WX3231N : **Normal/Full/Thru/4:3 zoom**

Remote control

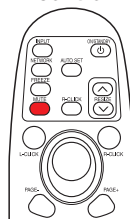





Remote control



Remote control



● How to set password (from [Off] to [On])

- 1 Select [Password] in the Default setting 2 menu and press the  or  button.
- 2 Select [Password setting] and press the  or  button.
- 3 Select [On].
- 4 Select [OK] and press the  button.
The password entry screen is displayed.
- 5 Enter the password using the numeric keys of the remote control.
- 6 The password setting will be set as [On].





● How to operate when password is [On]

- 1 Turn on the power.
- 2 The lamp lights and the password entry screen appears.
- 3 Enter the password using the numeric keys of the remote control.
If the entered password is correct, the start-up screen appears and the projector goes into normal operation. If the password is incorrect, a message will appear prompting you to re-enter the password, and the password entry screen is displayed again. If you enter an incorrect password more than 5 times, the projector will automatically power off and enter standby mode.

■ Note

- When the password setting is [On], the password function will be enabled only when the projector is restarted after the power cord has been unplugged. The password that you set will not be enabled when restarting from standby mode without unplugging the power cord.

● How to set password (from [On] to [Off])

- 1 Select [Password] in the Default setting 2 menu and press the  or  button.
The password entry screen is displayed.
- 2 Enter the password using the numeric keys of the remote control.
- 3 Select [Password setting] and press the  or  button.
- 4 Select [OFF].
- 5 Select [OK] and press the  button.

Using the menus 1

You can call up on-screen menus, and conduct a number of adjustments and settings using the **MENU** button [p.16](#) on the control panel of the main unit and remote control.





■ Setup using the Setting display

The menu shown below is for operation instructions purposes and might differ from the actual display.

1. Press the **MENU** button This will display the **Setting display** menu.
2. Select a Category

Select a category by using .

There are 5 categories:

-  **Image adjustment menu** [p.37](#)
-  **Display setting menu** [p.39](#)
-  **Default setting 1 menu** [p.42](#)
-  **Default setting 2 menu** [p.43](#)
-  **Status display menu** [p.45](#)



Displays the current adjustments and settings of the selected category. Items shown in gray cannot be adjusted with the current input source.

3. Adjustments & Settings Press  or  to open the menu.

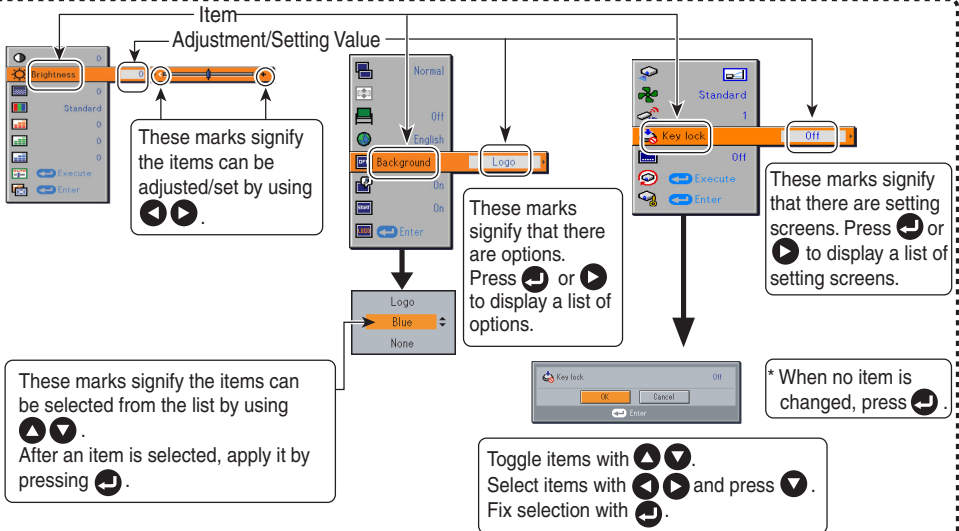

- The figure shows displays given for operation instructions purposes. As the display may differ depending on the item, refer to the following applicable pages for the menu item you desire.
- To return to previous item, press the RETURN button.
- When Network or USB memory input is selected, pressing the MENU button twice displays the Setting display (2) menu.

4. End Press the **MENU** button once more.















(The menu will disappear automatically after 30 seconds, if no operation is conducted.)

Note















- Menu adjustments and settings will not be saved, if the power cable is disconnected or the power goes out before the adjustments and settings have been completed and the menu display has been closed.

The image adjustment menu

Use this menu to set or adjust image related items. Items that can be set or adjusted are marked “Yes”, and those that cannot are marked “No”. (When an item is masked, it indicates that you cannot select it using the current input.)

Item ▲ ▼	Description	Computer	Y/Pb/Pr	HDMI	Video	S-video	Network	USB memory
 Contrast	Adjust the image contrast. Lower ◀ ▶ Higher	Yes	Yes	Yes	Yes	Yes	Yes	Yes
 Brightness	Adjust the brightness of the image. Darker ◀ ▶ Brighter	Yes	Yes	Yes	Yes	Yes	Yes	Yes
 Color	Adjust the color of the image. Lighter ◀ ▶ Deeper	No	Yes	No	Yes	Yes	No	No
 Sharpness	Adjust the sharpness of the image. Softer ◀ ▶ Sharper	Yes	Yes	Yes	Yes	Yes	Yes	Yes
 Noise reduction^{*1}	Set the function to reduce screen noise. On (Enable) ◀ ▶ Off (Disable)	No	Yes	No	Yes	Yes	No	No
 NCE	Switches the picture mode. Press  . Toggle the NCE mode with ▲ ▼. See p.33 for details.	Yes	Yes	Yes	Yes	Yes	Yes	Yes
 R-level	Adjust red of the image color. Less red ◀ ▶ More red	Yes	Yes	Yes	Yes	Yes	Yes	Yes
 G-level	Adjust green of the image color. Less green ◀ ▶ More green	Yes	Yes	Yes	Yes	Yes	Yes	Yes
 B-level	Adjust blue of the image color. Less blue ◀ ▶ More blue	Yes	Yes	Yes	Yes	Yes	Yes	Yes
 NTSC mode^{*2}	Set the black level with ◀ ▶. US : NTSC (US) mode JAPAN : NTSC (JAPAN) mode	No	No	No	Yes	Yes	No	No
 RGB input range^{*3}	Set the RGB input range with ◀ ▶. Standard : When black color becomes lighter. Full : When dark area becomes too dark.	No	No	Yes	No	No	No	No
 Auto setting	Automatically adjusts items such as the sampling phase depending on the type of input signal.	Yes	No	No	No	No	No	No
 Equalizer	Reduce noise on the screen. Adjust with ◀ ▶.	No	No	Yes	No	No	No	No

Using the menus 1 (Continued)

Item  	Description	Computer	Y/Pb/Pr	HDMI	Video	S-video	Network	USB memory
 Position	Press  then change mode using   and adjust with  	Yes	No	No	No	No	No	No
 Phase	Adjust to eliminate flicker.	Yes	No	No	No	No	No	No
 Frequency	Adjust to eliminate periodic patterns and flickering when many fine vertical lines appear on the screen.	Yes	No	No	No	No	No	No
 H-position	Adjust the horizontal position of the image.	Yes	No	No	No	No	No	No
 V-position	Adjust the vertical position of the image.	Yes	No	No	No	No	No	No
 Clamp 1	Adjusts the clamp pulse position.	Yes	No	No	No	No	No	No
 Clamp 2	Adjusts the clamp pulse width.	Yes	No	No	No	No	No	No

*1: [Noise reduction] may not work depending on signal type.













*2: [NTSC mode] can be displayed and adjusted only when the video signal is set to [NTSC] or [NTSC4.43]. NTSC mode is set to JAPAN when the language is set to Japanese. It is set to US for other languages.

*3: [RGB input range] can only be set with RGB signals via an HDMI™ cable.

■ The display setting menu

Use this menu to set screen display related items.

(The items in gray color cannot be set with the current input selection.)

Item ▲ ▼	Description
 Screen size	Screen size setting [⏪ or ⏩: Enter setting] → [▲ ▼: Selection] → [Enter: ⏩] X3241N : Normal/Full/Thru/Wide WX3231N : Normal/Full/Thru/4:3 zoom
 Up/down shift	Allows the projected images to shift vertically when the screen size setting is selected Wide for X3241N (within the range of 1024 x 768) and 4:3 zoom for WX3231N (within the range of 1280 x 800). Lower the image ◀▶ Raise the image
 Blackboard mode	When projecting on a non-screen surface, select a color in accordance with the projecting surface. Press ⏪ and switch with ▲ and ▼. Off/Green/Black/Brown/Blue/Beige
 Language	Select one of the languages below to use for displaying the menu and messages [⏪ or ⏩: Enter setting] → [▲ ▼ ◀ ▶: Selection] → [Enter: ⏩] English / Français / Deutsch / Italiano / Español / Português / Русский / Svenska / Türkçe / Polski / Norsk / Suomi / Čeština / Magyar / Ελληνικά / Dansk / Nederlands / Română / 日本語 / 中文(简体字) / 中文(繁體字) / 한국어 / Indonesia / العربية اللغة / ગુજરાતી
 Background	Screen to display when there is no input signal [⏪ or ⏩: Enter setting] → [▲ ▼: Selection] → [Enter: ⏩] Logo/Blue/None
 Icon	Display icons as function guides On ◀▶ Off
 Start-up screen	Display start-up screen when power is turned on On ◀▶ Off
 User logo	Display a logo customized by the user for the start-up screen or when there is no input signal. [⏪ or ⏩: Enter setting] → [▲ ▼: Selection]
 Logo registration	Press ⏪ to display the registration menu.
 Display style	<input type="checkbox"/> ◀▶ <input type="checkbox"/>
 Background	Black ◀▶ Blue ◀▶ White
 Logo confirmation	Press ⏪.
 Reset logo	Yes ◀▶ No

Using the menus 1 (Continued)

Detailed description

[Screen size]

- **Normal** : Enlarges an input image to fit the screen without changing the aspect ratio of video signals.
- **Full** : Displays an input image in 1024 × 768 dot resolution by enlarging it to fill the entire screen. (X3241N)
Displays an input image in 1280 × 800 dot resolution by enlarging it to fill the entire screen. (WX3231N)
- **Thru** : Displays an input image in the native resolution of the video signals. Thru display is not available for Y/Pb/Pr, HDMI (Y/Pb/Pr signal), Video and S-Video-input images. The larger image than the screen size will be displayed over the screen. The input image may appear vertically long with some frequencies of video signals.
- **Wide (X3241N)** : Displays an input image in the center of the screen with a 16:9 aspect ratio by enlarging it to fit the width of the screen. The upper and lower portions of the image will be compressed.
Wide display is not available for Computer, HDMI (RGB signal) and Network-input images.
- **4:3 zoom (WX3231N)** : Displays an input image with a 4:3 aspect ratio by enlarging it vertically.
The enlarged image will be displayed over the screen. 4:3 zoom display is not available for Computer, HDMI (RGB signal) and Network-input images.
- For Y/Pb/Pr and HDMI (Y/Pb/Pr signal) input, screen size setting function is not available for the video signals with a 16:9 aspect ratio.
- For the Network-input images, the size can be set only when the image is displayed.
- The size setting is not available when the projector is connected to your computer using the Network Projector (Windows Vista®, Windows® 7) function. It may fail to display the image to fill the entire screen with some input image sizes.
- For the USB memory-input images, the size cannot be set.

Note

- Using the screen size setting function on commercial video software, broadcast or cable-broadcasting programs to display images with the varying aspect ratio except for the purpose of your private viewing and listening may infringe the copyright protected by the copyright laws.

[Up/down shift]

Shifts the projected image vertically when [Screen size] is set to [Wide] for X3241N.

Shifts the projected image vertically when [Screen size] is set to [4:3 zoom] for WX3231N.

[Blackboard mode]

Projects the image in colors similar to projecting on a screen.

Precaution

- The projected image may differ depending on the type, color, and material of the blackboard and wall even if the selected color is the same as the projected screens.

[Background]

- RICOH is set for [Logo] by factory setting.
- If user's logo has been registered, it is displayed when [Logo] is set for background.

[Start-up screen]





If user's logo has been registered and this setting is [On], the logo is displayed at start-up.

[User logo]

Part of the image that is input from a computer is registered as a stationary picture and is displayed it as a logo at start-up and when no signal is input.

<Logo registration>

● How to register user logo

- ① Project a picture to register.
- ② Select [User logo] in the Display setting menu, and press the  or  button.
- ③ Select <Logo registration> from the displayed menu list and press the  button.
- ④ The registration area is displayed for confirmation. Select [OK] and press the  button.
 - If the picture does not fall within the display area, use the computer to scroll the screen.
- ⑤ Select [Yes] to register and press the  button.
- ⑥ Registration starts.
 - A message is displayed while registration is in process.

■ Notes

- You can register a logo when the input is set to Computer, HDMI (RGB signal), Network or USB memory.
- For the Network-input, a logo can be registered only when the image is displayed.
- For the USB memory-input, a logo cannot be registered when a thumbnail list is displayed.
- The area that can be registered is 512 x 384 dots for X3241N and 640 x 400 dots for WX3231N at the center of the screen. To register a company logo, modify the image within that space.
- Only one logo can be registered. When a new image is registered, the old one is deleted.
- The time needed to register or display the image varies depending on the data size.
- Using this function on commercial video software, broadcast or cable-broadcasting except for the purpose of your private viewing and listening may infringe the copyright protected by the copyright laws.

<Display style>

Select the size of the registered logo.

 : Displays the registered image in the original size at center of the screen.

 : Displays the registered image by enlarging it fully within the screen.
(As processed digitally, the image quality is degraded.)

<Background>

Sets background color when [Center] is selected for the logo [Display style].

<Logo confirmation>

You can preview the registered logo.

<Reset logo>

You can reset the registered logo, display style and background to the factory setting. (The logo set for the start-up screen and background is reset.)

Using the menus 1 (Continued)

■ The default setting menu

This menu shows placement status and other settings.

Default setting 1 menu

Item ▲ ▼	Description
Auto keystone	Always corrects keystone distortion automatically. On ◀ ▶ Off
No signal power off	Sets the time to wait for the power to be turned off after the last operation is made with no input signal. Off (not turned off) ◀ ▶ 30 min.
Auto input search	Sets whether the input with signals is only selected or not. On ◀ ▶ Off
Network input detection	Sets how to detect the Network input when Auto input search is [On]. Always ◀ ▶ Normal
Beep	Beeps when operation is made. On ◀ ▶ Off
Voice guide	Informs the operation status and abnormal conditions. Off ◀ ▶ Small ◀ ▶ Loud
Power on	Sets whether to turn on the power when the ON/STANDBY button is pressed (Manual), or when the power cord is plugged in (Auto). Manual ◀ ▶ Auto
Network standby	Switches on/off the network while the projector is in standby. On ◀ ▶ Off
Lamp power	Sets the lamp power. Low ◀ ▶ Standard

● Detailed description

[Auto input search]

[On]: Automatically searches the signals that can be projected, and switches input from the connected device that outputs the video signals each time the **INPUT** button is pressed. Input from a connected device that outputs no video signals is skipped.

[Off]: Displays the **Input select** menu.
Toggle with ▼ ▲ buttons and press ◀ button.
(The input without signals can be also selected.)

■ Note

- In normal operation, set [Auto input search] to [On]. Set to [Off] when you want to select the input source from Input select menu, or if the image does not appear properly.

[Network input detection]

If [Always] is set, even while no images are being sent to the projector through the Network input, the Network input will be selected when the **Auto input search** is [On].

If [Normal] is set, the Network input is selected only while images are being sent to the projector through the Network input.

■ Note

- It is recommend that you set the [Network input detection] to [Normal] as long as you do not use the Network input.
- When the projector is in network input mode and [Network input detection] is set to [Always], the projector does not switch to another input signal automatically even if [Auto input search] is set to [On]. Press the **INPUT** button to switch to another input signal.

Input select menu

Input select	
●	Computer 1
○	Y/P _B /P _R 1
●	Computer 2
○	Y/P _B /P _R 2
●	HDMI
●	Video
○	S-video
●	Network
●	USB memory

●/○ shows whether signal is input or not.

[Voice guide]

Even when you set the [Voice guide] to [Off], it still informs you of the abnormal conditions.

[Power on]

If [Power on] is set to [Auto] and there is a power outage, the projector will come on once power is restored.











[Network standby]

When [Network standby] is set to [On], the network is switched to the standby state as the projector enters standby. While the network is in standby, the projector can be powered on using the remote control function of the Network Utility. When [Network standby] is set to [Off], the projector cannot be powered on with the remote control function of the Network Utility.

[Lamp power]

When [Lamp power] is set to [Low], the screen becomes a little darker, but the cooling fan noise gets quieter.

Default setting 2 menu

Item ▲ ▼	Description
 Projection mode	Sets projection mode in accordance with Placement Style. p.21  (Standard) ◀ ▶  (Rear) ◀ ▶  (Ceiling) ◀ ▶  (Rear ceiling)
 Fan mode	Sets the cooling fan speed. Standard ◀ ▶ High
 Remote control	When 2 projectors are used and controlled by the remote control respectively, this menu sets the code for the projector and the remote control. [▲] or [▶]: Enter setting] → [●] [●]: Select from 1, 2] → [▼]: Confirm] → [●] [●]: Select OK to end] Press [Cancel] to return.
 Key lock	Lock the control panel buttons. [▲] or [▶]: Enter setting] → [●] [●]: Select On/Off] → [▼]: Confirm] → [●] [●]: Select OK to end] Press [Cancel] to return.
 Closed Caption	Closed Caption settings. Press [▲] or [▶] and switch with [▲] and [▼]. Off/ CC1/ CC2/CC3/CC4/T1/T2/T3/T4
 Reset all	Press [●]. (The password and user logo are not reset.) Resets all adjustments and settings to their factory settings. Yes ◀ ▶ No
 Password	Password setting p.34 Press [●]. → Password registration/Password setting

● Detailed description

[Fan mode]

Setting [Fan mode] to [High] increases the cooling fan speed. (The cooling fan noise increases.) Set this option to use the projector at high altitude (over 1,500 meters above sea level).

- Do not set Fan mode to [High] when using the projector at a lower altitude.

Using the menus 1 (Continued)

[Remote control]

Sets a remote control code from 2 types. You can set each code respectively for up to 2 projectors. The factory setting is [1].

To switch codes, set the same code for the projector and the remote control.

A remote control code is applied after the setting is done.

- You cannot operate the remote control if the codes of the projector and the remote control do not match.

Remote control code setting for remote control

Set the same **remote control code switch** as the projector. [p.16](#) [p.17](#)

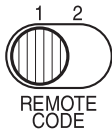

[Key lock]

Avoid operating errors by locking the projector's control panel buttons. (The remote control operations are still available.)

Control panel operations are locked after the setting is done, and operations using the control panel buttons are disabled.

- To release the key lock, set the **[Key lock]** to **[Off]** using the remote control. You can also set the **[Key lock]** to **[Off]** by pressing the **[RETURN/MUTE]** button on the projector for 10 seconds. (When operating the main unit, the LAMP and TEMP indicators will glow orange for 3 seconds, and the projector will beep.) Note that when Network or USB memory input is selected, the **[Key lock]** cannot be set to **[Off]** with the **[RETURN/MUTE]** button on the projector.

[Closed Caption]

- **Off** : Closed Caption is not displayed.
- **CC1-CC4** : Displays the dialogue and narration of TV programs and videos that are **(Caption)** closed captioned.
- **T1-T4** : Displays information not related to the current program, such as weather, **(Text)** stock data or the like, when it is provided by individual station.

Note

- This projector supports a special feature called closed captioning which allows subtitles to be displayed at the bottom of the picture. This is pursuant to the Regulations set forth by the US Federal Communications Commission (FCC). Due to the different broadcasting or signaling system, it may not operate correctly in other regions or countries where TV programs do not support closed captioning.
- Closed Caption may not appear correctly depending on the signal conditions or the recording conditions of videotapes.
- If the **Text** is not available, only a black rectangle background may appear on screen. To prevent this from appearing, set the Closed Caption to **[Off]**.
- When you switch channels of broadcasting programs or play a videotape using "trick play" functions such as rewind or fast-forward, the operations in the connected device may cause the **Caption** or **Text** to remain on the screen for a while.
- Closed Caption is available for Video and S-Video input images.

■ Displaying Information (Status display)

This displays information about the input signal, lamp use time, etc.

“Yes”: displayed, “No”: not displayed

Item	Description	Computer	Y/Pb/Pr	HDMI	Video	S-video	Network	USB memory
Input	Input source name	Yes	Yes	Yes	Yes	Yes	Yes	Yes
Mode name	RGB or HDMI signal mode ^[Note 1]	Yes	No	Yes	No	No	No	No
Resolution	Resolution (in dots)	Yes	No	Yes	No	No	No	No
Frequency	Sync frequency	Yes	No	Yes	No	No	No	No
Sync	Sync signal polarity ^[Note 2]	Yes	No	No	No	No	No	No
Signal format	Y/Pb/Pr signal format	No	Yes	No	No	No	No	No
Video mode	Color method of video signal	No	No	No	Yes	Yes	No	No
Lamp time	Time of lamp use ^[Note 3]	Yes	Yes	Yes	Yes	Yes	Yes	Yes
Lamp reset count	The count for lamp replacement	Yes	Yes	Yes	Yes	Yes	Yes	Yes
Total time	The total time that this projector is used.	Yes	Yes	Yes	Yes	Yes	Yes	Yes
Version	Firmware version ^[Note 4]	Yes	Yes	Yes	Yes	Yes	Yes	Yes

Notes

- 1: The mode of supported RGB signals [p.100](#) and HDMI signals [p.101](#) are shown.
- 2: Sync signal polarity shown as P (positive) or N (negative) for [H/V].
- 3: Displays [**Lamp time**] as an estimated measure of when the lamp should be replaced. (Cannot be used as a counter of guaranteed lamp time.)
- 4: [**Version**] shows the version of the projector's internal control program. This version will be requested for customer service purposes.

■ Note

- The displayed information will not be refreshed if the status changes. To refresh the information, dismiss the display, then display it again.

Before connecting via a network

Check your computer's Operating System before you connect a projector with your computer via a network.

This projector supports the **Network Projector** function of **Windows Vista®** and **Windows® 7** features.

- If your computer's Operating System is **Windows Vista®** or **Windows® 7**, and you intend to use the **Network Projector** function for network connection, see “**Connection using the Network Projector (Windows Vista® or Windows® 7)**” [p.46](#), “**Setting up the Network Projector/Network Utility**” [p.51](#) and “**Using the Network Projector**” [p.61](#).
- If your computer's Operating System is **Windows® 2000** or **Windows® XP**, see “**Connection using the Network Utility**” [p.46](#), “**Setting up the Network Projector/Network Utility**” [p.51](#) and “**Using the Network Utility**” [p.64](#).

■ Connection using the Network Projector (Windows Vista® or Windows® 7)*

* Now referred to as “Network Projector.”

● Functions

By using the **Connect to a Network Projector wizard**, you can connect to any projectors which support the **Network Projector** function over a wireless or a wired network.

You can make a presentation without any connection setting issues.

■ Notes

- This function's operation has been verified on the **Ultimate** and **Business** editions of **Windows Vista®**, **Professional** and **Ultimate** editions of **Windows® 7**.
- To communicate in Ad hoc mode with a computer over wireless LAN also requires IP address settings.
- In case the resolution of your computer is higher than that of the projector, your computer must be set at lower resolution.
- Transferring video images and audio sound is not available.
- This function does not work while the projector is connected to your computer using the **Network Utility** software.

■ Connection using the Network Utility

● Functions

The following functions are available with the wired LAN, or via wireless LAN when the LAN dedicated application software: [**Network Utility**] [p.64](#) included with this projector is used.

1) Displaying a computer's screen via the projector

The computer's desktop screen can be sent, as well as the screens of a variety of software applications, to the projector for display. Likewise, the sound being played on a computer can also be sent to the projector. Using the Network Mouse Controller function, you can operate your computer with the projector's remote control.

2) Displaying a JPEG file saved on a computer via the projector

JPEG files can be sent to the projector for display.

3) Displaying a video image saved on a computer via the projector

Video files can be sent to the projector for image display. As well, the sound stored in the video file is sent to the projector.

4) Displaying computer's screens via projectors using the Multiscreen function

This function allows users to display multiple screens by sending data to different projectors from a single computer by setting up the virtual displays on the computer. You can also send only the screens that you specify to the projector for display.

5) Operating the projector by means of a computer

Some of the same functions available from the remote control can be performed.

Note

- Network Utility is also operable with Windows Vista® or Windows® 7.

Communication mode

The wireless LAN of this projector supports both Ad hoc and Infrastructure Communication modes.

◆ Ad hoc communication mode

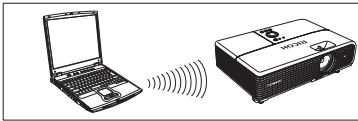

This is the transmission mode to communicate between wireless LAN equipment.

This mode is applicable, for example, to a presentation in the conference room, as it requires no other facilities. This function can only be used if

the projector is in range of the computer's wireless signals.

Ricoh does not guarantee the coverage of the radio wave in the form of figures. The coverage varies depending on the performance of each wireless LAN equipment, existence of obstacles or other wireless LAN equipment used by nearby working groups, etc. The coverage is generally estimated on the assumption that wireless LAN equipment be used in an unobstructed office or conference room.

◆ Infrastructure communication mode

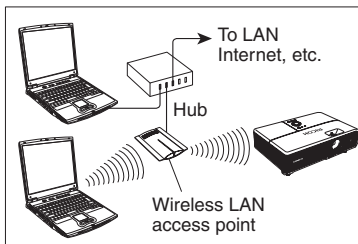

A mixed wireless and wired LAN can be created via wireless LAN access points. (Communications between wireless LAN devices are also allowed.) Connecting to the rest of the world via a wired LAN or the Internet generally requires a high level of security.

Use the appropriate transmission mode for your network environment.

Caution when using the wireless LAN functions

The Wireless LAN in this unit uses the 2.4 GHz waveband. If there is a similar wireless LAN in the area, or a wireless device using the 2.4 GHz waveband, or a microwave oven, the communication efficiency of this apparatus will be reduced, and may become unusable, but it is not a fault. If this happens, check an area away from the current location that will not cause radio interference to medical, industrial and public equipment, and change to it, or stop using the unit.

How to use the USB terminal

This projector can connect to a commercial USB memory device and a USB memory card reader/writer that are USB2.0 compliant, a digital camera or the like and display the JPEG and MPEG files saved in those devices. [p.49](#)

(Ricoh does not guarantee the operation of all USB 2.0-compliant devices.)

To connect or disconnect a USB device, use the following procedure:

■ Connecting USB device

Plug in the USB device.

Make sure the orientation is correct then plug in the USB device until it is secure.

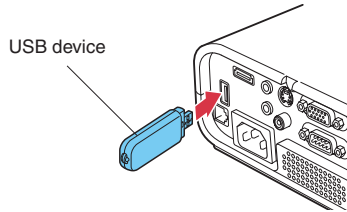

■ Disconnecting USB device

- ① **Switch the input to USB memory and press the MENU button twice to display the Setting display (2), then select and run [Unplug device] in the Slideshow setting menu.**
The process for disconnecting a USB device starts.
- ② **The message “This USB device can be unplugged safely” appears on the screen.**
- ③ **Unplug the USB device.**

CAUTION

- **Be sure to perform the above steps. Disconnecting a USB during operation may cause a system malfunction or data corruption.**

■ Notes

- A USB device can be plugged in even when the power is on.
- The projector may not recognize a supported USB device. If that happens, unplug the USB device then plug it in again.
- The USB terminal does not support the supplied mouse remote control receiver or a commercial mouse controller.
- A USB hub is not supported.

■ Precaution

- Disconnecting the power plug while the USB device is operating may cause a malfunction or data corruption.

■ USB memory devices

This projector can read JPEG, MPEG1, and MPEG2 (PS) files stored in a USB memory device and display them on the screen.

This allows you to give presentations without a computer, create an advertising screen board using the slideshow function, and more. (The projector cannot reproduce animation effects such as those produced by Microsoft® PowerPoint®.)

● The USB terminal

The USB terminal of the projector is USB2.0 compliant and can connect with a USB memory device, a USB memory card reader/writer, a digital camera and other similar devices. For USB devices whose operation has been verified, please contact your sales representative.

Note that this projector does not support all USB memory devices, USB card readers/writers, and digital cameras.

■ Backing up data

Ricoh recommends that you back up the data saved in the USB memory device onto your computer or storage device before use. Ricoh assumes no liability for losses incurred by data lost through the use of this projector.

■ Supported files

- (1) Supported file extensions are .jpg, .JPG, .jpeg, .JPEG, .mpg, .MPG, .mpeg, and .MPEG.
- (2) The maximum number including both folders and files is 512.
- (3) Some JPEG and MPEG files are not supported by this projector.

Regarding JPEG files, the limitations in (3) above can be alleviated by converting the JPEG file with the supplied **JPEG Conversion Tool** [p.83](#) software application.

Using the menus 2

■ Setup using the Setting display (2)

● Projector settings (Be sure to read this subsection.)

Using the factory settings as-is may suffer security damage, so be sure to change the projector settings.

1. Press the MENU button twice

2. Select a Category

The Setting display (2) is displayed.

* Appears only when Network or USB memory input is selected.

Select a category by using



The following 5 categories are available:



Network Projector setup p.51



Network utility setup p.51



Control setting p.57



Slideshow setup p.58



Status display p.60



Displays the current settings of selected category.

Item shown in gray cannot be set with the currently set conditions of the projector.

3. Make settings

Press or to open the menu.

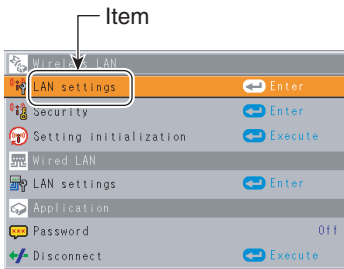

These marks signify the items can be selected from the list by using . After an item is selected, apply it by pressing .

The figure shows a typical example. As the display may differ depending on the item, use the following pages as a reference.

While the video file transfer function of Network Utility or the slideshow function is in use, the background image of the Setting display (2) does not appear.



















4. Back RETURN button

5. End Press the MENU button or RETURN button.

(The menu disappears 30 seconds after the last operation is conducted.)

■ Setting up the Network Projector/Network Utility

If you select **Network Utility**, the following items can be set.

Category	Item ▲ ▼	Description
Wireless LAN	 Easy Connect (USB memory)	[Yes ◀ ▶ No] → [Enter: ⏎]
	 LAN settings	 Mode: Ad hoc ◀ ▶ Infrastructure
		 SSID: Specify a desired character string (1 to 32 characters). [◀ ▶]: Move left or right one character. ↔ [(0) to (wxyz)]: Set a character.]
		 DHCP: Use ◀ ▶ Not use
		 IP address: Enter using the numeric keys of the remote control. [◀ ▶]: Move left or right one character. ↔ [(0) to (wxyz)]: Set a character.]
		 Subnet mask: Enter using the numeric keys of the remote control. [◀ ▶]: Move left or right one character. ↔ [(0) to (wxyz)]: Set a character.]
		 Gateway: Enter using the numeric keys of the remote control. [◀ ▶]: Move left or right one character. ↔ [(0) to (wxyz)]: Set a character.]
		Confirm: [OK] ◀ ▶ [Cancel] → [Enter: ⏎]
	 Security	 Network authentication: Network Authentication Setting [◀ ▶] or [▶ ▶]: Enter setting → [▲ ▼]: Selection → [Enter: ⏎] None/Open/Shared/WPA-PSK/WPA2-PSK
		 Encryption: Select an encryption type using the ◀ ▶ button. Off/WEP/TKIP/AES
 Key index: Select a desired number (1 to 4) using the ◀ ▶ buttons.		
 Network key: Specify a desired character string. (WEP: 5 to 13 characters, or 10 to 26 digits in hexadecimal notation) (TKIP/AES: 8 to 63 characters, or 64 digits in hexadecimal notation) [◀ ▶]: Move left or right one character. ↔ [(0) to (wxyz)]: Set a character.]		
Confirm: [OK] ◀ ▶ [Cancel] → [Enter: ⏎]		
 Setting Initialization	Reset all the wireless LAN settings. Confirm: [Yes] ◀ ▶ [No] → [Enter: ⏎]	
Wired LAN	 LAN settings	 DHCP: Use ◀ ▶ Not use
		 IP address: Enter using the numeric keys of the remote control. [◀ ▶]: Move left or right one character. ↔ [(0) to (wxyz)]: Set a character.]
		 Subnet mask: Enter using the numeric keys of the remote control. [◀ ▶]: Move left or right one character. ↔ [(0) to (wxyz)]: Set a character.]
		 Gateway: Enter using the numeric keys of the remote control. [◀ ▶]: Move left or right one character. ↔ [(0) to (wxyz)]: Set a character.]
		Confirm: [OK] ◀ ▶ [Cancel] → [Enter: ⏎]

Network/
USB memory

* To enter characters, use the numeric keypad on the remote control.

Using the menus 2 (Continued)

Category	Item ▲ ▼	Description
Application	Remote control	Specify whether to allow the remote control of the projector from a computer. Allowed ◀ ▶ Presentation ◀ ▶ Forbidden Allowed: The projector always accepts remote commands from a computer. Presentation: Accepts only the remote commands from the computer by which an image is projected on the projector (Update automatically) using Network Utility. Forbidden: Always ignores any remote commands from a computer.
	WEB browser	Browser authentication: Switch on/off the password authentication for access to the setting screen using the Projector Configuration Tool. On ◀ ▶ Off
		Password: Enter the password used to access the setting screen when the Browser authentication is set to On . A character string (1 to 8 characters) can be specified as desired. ◀ ▶ : Move left or right one character. ↔ [P] to [wxyz] : Set a character. Confirm: [OK] ◀ ▶ [Cancel] → [Enter:]

* To enter characters, use the numeric keypad on the remote control.

● Character entry

Enter characters using numeric keys of the remote control. The character is entered with a beep sound if the beep sound is set to [On].

Character entry mode		
Remote control button	Items using characters, numbers, and symbols (e.g., projector name and destination address)	Number only
[1] [.] [0]	“1” “.” “@” “-” “_”	“1”
[2] [ABC]	“2” “A” “B” “C” “a” “b” “c”	“2”
[3] [DEF]	“3” “D” “E” “F” “d” “e” “f”	“3”
[4] [GHI]	“4” “G” “H” “I” “g” “h” “i”	“4”
[5] [JKL]	“5” “J” “K” “L” “j” “k” “l”	“5”
[6] [MNO]	“6” “M” “N” “O” “m” “n” “o”	“6”
[7] [PQRS]	“7” “P” “Q” “R” “S” “p” “q” “r” “s”	“7”
[8] [TUV]	“8” “T” “U” “V” “t” “u” “v”	“8”
[9] [WXYZ]	“9” “W” “X” “Y” “Z” “w” “x” “y” “z”	“9”
[0] []	“0” “space!” “#” “\$” “%” “&” “'” “(” “)” “*” “+” “-” “:” “;” “<” “=” “?” “@” “[\]^_`{ } ~”	“0”
[CLEAR]	Deletes one character.	Deletes one character.

● Details on individual items

• [Wireless LAN settings]

<Easy Connect (USB memory)>

This feature allows users to easily connect the projector to a computer over a network, without making **Wireless LAN settings** using **Network Utility**.

<Mode>

Your projector is set to **Ad hoc** in the factory. Change the setting if you want to use the projector in **Infrastructure** mode.

<SSID>

This is an ID code for connecting to specific individuals over a wireless LAN. This may also be called "**Network group**" or "**Network name**". Please read the following carefully.

Note: When you use Ad hoc communication mode, if there is a similar **SSID** network group (for example, RDPJ1, RDPJ2, etc.) in the possible communication area, it is possible that your projector name will not be displayed in the **Network Utility** projector list column. If this is the case, set **SSID** to a completely different character string.

Set the following items if you have set the communication mode to Infrastructure. If you have set the communication mode to Ad hoc for Network Projector setting, the following items should also be set.

<DHCP>

If you set **DHCP** to **Use**, the IP address of the projector is assigned automatically by the DHCP server. If your network environment does not assign IP addresses automatically, set **DHCP** to **Not use**, then set the following items **IP address**, **Subnet mask** and **Gateway** manually.

<IP address>

When **DHCP** is set to **Not use**, consult with your network administrator for the settings below and set the **IP address** manually.

An IP address is a unique number assigned to a terminal. The format is a string of four dot-separated three-digit numbers. (Example: 111.112.xxx.xxx)

Note: If you set the same IP address for wireless LAN with the one for wired LAN, network function may fail to operate properly.

<Subnet mask>

A subnet mask is used to determine what subnet the IP address assigned to a terminal belongs to. (Example: 255.255.xxx.xxx)

Note: If you set the same subnet work for wireless LAN with the one for wired LAN, network function may fail to operate properly.

<Gateway>

This value specifies the IP address of the device, such as a router, to be used to access servers outside the network. (Example: 111.112.xxx.xxx)

Using the menus 2 (Continued)

- **[Security for wireless LAN settings]**

<Network authentication>

Set the authentication to enhance network security. Select a method identical to that of the wireless LAN terminal to be connected with.

<Encryption>

Set **Encryption** according to the setting you made for **Network authentication**, as follows.

When you have set **Network authentication** to **Open** or **Shared**, select **WEP** for **Encryption**.

When you have set **Network authentication** to **WPA-PSK/WPA2-PSK**, select **TKIP** or **AES** for **Encryption**.

Note: **Network authentication** is factory-set to **None**. If you use the projector with this setting left unchanged, security may be compromised due to access by a third party within the projector's coverage.

<Key index>

When you have set **Encryption** to **WEP**, Key index must be set. By default, "1" is selected. Select a key index identical to that of the wireless LAN terminal to be connected with.

Note: Since the range of key index varies by product type (1 to 4 or 0 to 3), make settings with attention.

<Network key>

When you have set Encryption to [WEP]:

- For use at an encryption level of 64-bit, specify a string of 5 arbitrary characters or a string of 10 characters in hexadecimal notation.
- For use at the 128-bit level, specify a string of 13 arbitrary characters or a string of 26 characters in hexadecimal notation.

When you have set Encryption to [TKIP]/[AES]:

Specify a string of 8 to 63 arbitrary characters or a string of 64 characters in hexadecimal notation.

Note 1: Alphabetic characters (A to F, a to f) used in hexadecimal notation are not case sensitive; the uppercase characters and their lowercase equivalents are handled to be identical.

Note 2: The longer the strings of characters set for the Network key, the stronger the encryption becomes, and hence the harder it will be for a third party to decipher your communications. However, the setting of larger encryption may slow down communication speed.

Note 3: To set a higher security level, specify a longer string of characters. For higher security, avoid using a word found in a dictionary and change the key sometimes.

<Setting initialization>

This item resets the wireless LAN settings to their factory defaults.

- **[Wired LAN settings]**

- <**DHCP**>

- If you set **DHCP** to **Use**, the IP address of the projector is assigned automatically by the DHCP server. If your network environment does not assign IP addresses automatically, set **DHCP** to **Not use**, then set the following items **IP address**, **Subnet mask** and **Gateway** manually.

- <**IP address**>

- When **DHCP** is set to **Not use**, consult with your network administrator for the settings below and set the **IP address** manually.

- An IP address is a unique number assigned to a terminal. The format is a string of four dot-separated three-digit numbers. (Example: 111.112.xxx.xxx)

- Note: If you set the same IP address for wireless LAN with the one for wired LAN, network function may fail to operate properly.

- <**Subnet mask**>

- A subnet mask is used to determine what subnet the IP address assigned to a terminal belongs to. (Example: 255.255.xxx.xxx)

- Note: If you set the same subnet work for wireless LAN with the one for wired LAN, network function may fail to operate properly.

- <**Gateway**>

- This value specifies the IP address of the device, such as a router, to be used to access servers outside the network. (Example: 111.112.xxx.xxx)

- **[Application]**

- <**WEB browser**>

- Browser authentication**

- Browser authentication** and **Password** are factory-set to **Off** and no string, respectively. You should set them as soon as possible.



- Password**

- If you have forgotten your password, set it again using the menu on the main unit.

Using the menus 2 (Continued)

Note

- If you select [Network Projector] in the **Setting display (2)** menu, the same items in [Network Utility] will be displayed except for the following 2 items.
 - [Easy Connect (USB memory)] feature is not available.
 - In the item [Application], [Password] and [Disconnect] are available as follows.

Category	Item ▲ ▼	Description
 Application	 Password	Set password On ◀ ▶ Off
	 Disconnect	Disconnect while transferring an image using Network Projector. [Yes ◀ ▶ No] → [Enter: ⏎]

See “**Setting up the Network Projector/Network Utility**” [p.51](#) to conduct adjustments and settings for Network Projector.

Computer settings

Refer to your computer’s instruction manuals or wireless LAN adapter to perform the following settings.











- Select **Ad hoc** (for some wireless LAN adapters, this is **Peer-to-Peer Group**).
- Set **SSID** (for some types of wireless LAN adapter, use **Network name** instead) as the same as projector’s **SSID** (at factory shipment, this is set to **RDPJ**).
- If **Encryption**, **Network authentication**, **Key index** and **Network key** are set on the projector, set to the same values.

Note

- The Easy Connect utility [p.75](#) allows users to easily connect the projector to a computer over wireless networks, without making wireless LAN settings. For Easy Connect support, the computer requires a wireless LAN environment that is NDIS5.1 or higher driver compliant.
Refer to the user’s manual supplied with the wireless LAN adapter or the wireless LAN embedded computer for more information.

■ The control setting menu

This menu sets Projector name, Email function and PJLink function, etc. Select **Control setting** in step 2 in “**Projector settings**” p.50. The following content will be displayed.

Item ▲ ▼	Description
 Projector name	Specify a desired character string (0 to 16 characters). [⏪ or ⏩ : Enter setting.] → [⏪ ⏩ : Move left or right one character.] → [⏪ ⏩ to wxyz : Set a character.] → [✔ : Confirm] → [⏪ ⏩ : Select OK to end] Press [Cancel] to return.
 Email	[⏪ : E-mail setting] → [▲ ▼ : Select item]
 Status notification: On ⏪ ⏩ Off	
 SMTP server:	Enter a character string using numeric keys of the remote control.
 Port number:	Enter a character string using numeric keys of the remote control.
 Destination address:	Enter a character string using numeric keys of the remote control.
	Confirm: [OK ⏪ ⏩ Cancel]
 PJLink	[⏪ : PJLink setting] → [▲ ▼ : Select item]
 PJLink authentication: On ⏪ ⏩ Off	
 Password:	Enter a character string (1 to 32 characters) using numeric keys of the remote control.
	Confirm: [OK ⏪ ⏩ Cancel] → ⏪
 Wireless network	[⏪ or ⏩ : Enter setting.] → [⏪ ⏩ : Select from Enabled, Disabled] → [✔ : Confirm] → [⏪ ⏩ : Select OK to end] Press [Cancel] to return.

● Detailed description

• [Projector name]

This can be used to identify projectors when communicating with multiple projectors, or if there is a possibility that another person who is out of communication range will be using the same projector. It is recommended this is set to prevent incorrect transmission.

• [Email]

<**Status notification**>: Sends alarm information to the specified E-mail address when an error such as lamp failure occurs.

<**SMTP server**>: Set an IP address of the SMTP server.

<**Port number**>: Enter a port number of the SMTP server.

<**Destination address**>: Enter within 60 characters. (Example: xxx@xxx.xxx)

• [PJLink]

<**PJLink authentication**>: Set whether or not to authenticate the user by password when the projector is accessed via the **PJLink**-compliant Software Application. (Set [On] or [Off].)

<**Password**>: Enter a password for confirmation when the above <**PJLink authentication**> is set to [On].

Using the menus 2 (Continued)

■ Precautions

- When purchased, <PJLink authentication> is set to [Off] and <Password> is not set by factory setting. You are recommended to make authentication setting as soon as possible.
- If you forget a password, set it again.
- [Wireless network]
If you set **Wireless network** to **Disabled**, the wireless LAN connection will be unusable. Set **Wireless network** to **Disabled** when you do not wish to use the wireless LAN for network connection.











■ Note

- The Email function does not support transmission to the SMTP server that requires authentication.

■ Setting slideshow options

Slideshow is the function to allow users to display JPEG and MPEG image files saved in a USB memory device.

If you select **Slideshow**, the following items can be set.

Category	Item ▲ ▼	Description
 Still Image	 Auto. demo	On ◀ ▶ Off (Select whether to automatically start a slide show when a USB memory device is plugged.)
	 Interval	Select the slide show display interval. ◀ or ▶ : Begin a slide show. Use the ▲ ▼ buttons to select. 5 sec./10 sec./30 sec./1 min./3 min./5 min./10 min.
	 Display effect	Select the slide show display effect. ◀ or ▶ : Begin a slide show. Use the ▲ ▼ buttons to select. None / Wipe ↑ / Wipe ↓ / Wipe ← / Wipe → / Dissolve / Cover ↑ / Cover ↓ / Cover ← / Cover →
 Movie Image	 Auto. start	On ◀ ▶ Off (When a file is selected, start playing the file automatically.)
	 Repeat	On ◀ ▶ Off (Play repeatedly after the end of playing)
 Common	 Play icon	Standard ◀ ▶ Continuous
	 Thumbnail display	Switch the form of a thumbnail list. All ◀ ▶ File ◀ ▶ Off
	 Unplug device	Run when unplugging a USB device. Yes ◀ ▶ No

● Details on individual items

Still Image

- **[Auto. demo]**

On: A slide show begins automatically when a USB memory device is inserted and input switches to USB memory. At this time, the JPEG files in the root directory of the USB memory device are used in the slide show. If the input has already been switched to USB memory, the slide show begins automatically when the USB memory device is inserted.

- To pause the slide show, press the  button. Pressing this button again allows the slide show to begin. To stop the slide show, press the **RETURN** button.

Off: A list of thumbnails will be displayed when plugging in a USB memory device or other similar devices. Select a desired file from the list.

Notes

- The Auto Demo function does not work when using a USB memory card reader/writer to mount multiple media.
- The Auto Demo function is available for JPEG files only.

- **[Interval]**

You can set the display interval of time (in seconds or minutes) for slide shows to be played automatically.

Note

- It may take time to display slide show with some files.

- **[Display effect]**

When playing a slide show, the projector can give various display effects or transitions to each slide being displayed.

The transitions available are listed below:

- **None**

Displays each slide with no display effects.

- **Wipe**

Displays the next slide with a gradual upward (Wipe ↑), downward (Wipe ↓), to the left (Wipe ←), or to the right (Wipe →), over the current slide.

- **Dissolve**

Displays the next slide gradually in a certain fixed block pattern over the current slide.

- **Cover**

Displays the next slide as sliding upward (Cover ↑), downward (Cover ↓), to the left (Cover ←), or to the right (Cover →), over the current slide.

Movie Image

- **[Auto. start]**

On: Start playing a video file automatically when it is selected.

- **[Repeat]**

On: Repeat automatically from the beginning when the file reaches the end.

Using the menus 2 (Continued)

Common

- **[Play icon]**

The slideshow icon can be displayed.

- **Standard**

The projector handles the slideshow icon as follows depending on the “**On/Off**” setting of **Icon** on the projector’s menu.

Icon On: The projector displays the icon upon the start of playing a slide show and turns it off after a few seconds.

Icon Off: The projector does not display the icon.

- **Continuous**

The projector keeps the icon displayed during the slide show.

- **[Thumbnail display]**

Select the form of a thumbnail list.

All: Displays a thumbnail preview of JPEG files, and if any JPEG files exist in the folder displays the leading thumbnail image.

File: Displays only a thumbnail image of JPEG files. The thumbnail image of the JPEG files in the folder is not displayed.

Off: Displays an icon without displaying thumbnail preview.

Note

- Thumbnail image of MPEG files cannot be displayed.

- **[Unplug device]**

Run when unplugging a USB memory device, a USB memory card reader/writer or a digital camera and other similar devices.

Checking the projector status

Status display

To check the current status of the projector, select **Status display** in step 2 in “**Projector settings**” [p.50](#). The following items of information will then be displayed.

Application	The name of the application currently running on the projector is displayed. (Examples: Slideshow, Network Utility)
Details	<ul style="list-style-type: none">• When inputting from USB memory device “Free space/Status” are displayed.• When inputting from network For wireless LAN, “MAC address/Mode/Channel/SSID/Encryption/IP address/Subnet mask/Gateway” are displayed. For wired LAN, “Connection status/MAC address/IP address/Subnet mask/Gateway” are displayed.• PJLink class is displayed.
Version	The firmware version number of the network feature and the USB memory device feature is displayed.

Using the Network Projector

■ Setting up the projector

① Turn the projector power on.

② Switch the input to Network.

Make sure to set the projector's input to Network. If the other inputs are selected, the projector will not be recognized by the computer.

③ A password will be displayed.

A password will be displayed only when [Password] is set to [On] in the **Application** category of the **Network Projector settings**.

④ By referring to “Using the menus 2”, make the wireless LAN or wired LAN settings.

■ Setting up the computer

⑤ Make the wireless LAN or wired LAN settings. Please see the help function of your computer for details.

⑥ Open the [Connect to a Network Projector] wizard by clicking the [Start] button, by clicking [All Programs], then clicking [Accessories], finally clicking [Connect to a Network Projector].

⑦ Select the desired projector from the list or enter the projector address.

⑧ When the password is displayed in step ③, enter the password.

■ Precaution

- Before connection, be sure that either setting described below has been applied to your computer.
 - 1) The screen resolution of your computer is set in the following resolution depending on the projector you are using.
 - X3241N : XGA (1024 x 768 dots) or lower
 - WX3231N : WXGA (1280 x 800 dots) or lower
 - 2) Windows Vista® SP 1 (Service Pack 1) has been installed on your computer or your computer's operating system is Windows® 7.
 - For users of PJ WX3231N
 - If you are unable to set the screen resolution to 1280 x 800 with your computer whose resolution is higher than 1280 x 800, set it to lower than 1280 x 800 resolution.

Installing the applications

If you want to use the projector's internal wireless LAN function, install the Network Utility on the supplied CD-ROM onto your computer.

■ System Requirements

Supported Operating System: Windows® 2000, Windows® XP, Windows Vista® (Ultimate, Business), Windows® 7 (Professional, Ultimate)
CPU: Pentium M 1 GHz or higher recommended
RAM: 256 MB or more recommended
Screen area (resolution): 1024 by 768 dots recommended (X3241N)
1280 by 800 dots recommended (WX3231N)

* The system requirements may vary depending on the conditions of use.

■ Notes

- The Windows® XP, Windows Vista® and Windows® 7 64-bit versions are not supported.
- Some functions of applications may not be operational with Windows Vista® and Windows® 7.

■ Application Types and Major Functions

Network Utility

This application is used for network connections. Use it to send the images from the computer's screen to your projector, and display on the screen. In addition, also use it to transmit the sound being played on a computer to the projector.

JPEG Conversion Tool

Use to convert JPEG and other files into a format that can be displayed as a slide show using a USB memory device.

■ How to install

Double-click **setup.exe** in the **Network Utility** or **JPEG Conversion Tool** folder on the supplied CD-ROM. Follow the on-screen instructions.

If a message appears during installation, please respond to it to continue the installation process.

When installation is finished, the following shortcuts will appear on your computer's desktop:

If a message reporting a firewall block appears, select "**Allow access**".

Network Utility →



Operations [p.64](#)

JPEG Conversion Tool →



Operations [p.83](#)

■ How to uninstall

Uninstall [**RICOH Network Utility**] and [**RICOH JPEG Conversion Tool**] programs by using a program removal utility found in the [**Control Panel**] on your computer.

■ Notes

- Your computer screen may temporarily go out during installation, but it is not an error.
- Before beginning installation or uninstallation, you need to log on as Administrator.
- For Windows Vista® and Windows® 7, an error message may appear at the end of uninstallation when “automatic restart” is selected. However, this is not an error so that the computer will restart itself and uninstallation process will be completed.
- When using the **Network Utility** under Windows Vista® or Windows® 7, you must login as an administrator, or enter the password used at start up by a user with administrator’s permissions.

Using the Network Utility

■ Displaying a computer's screen via the projector

1 Launch the Network Utility software application.

When the **Network Utility** launches, the **Screen Image** transmission mode window appears on the computer screen.

To switch to the **Screen Image** transmission mode window from another mode, click the **Screen Image** icon .

If a message reporting a firewall block appears, select **“Allow access”**.

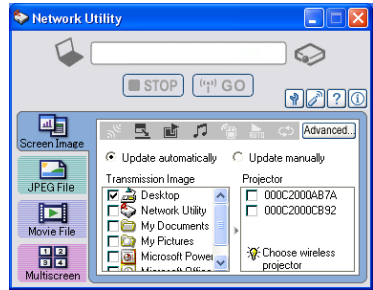

2 Select Transmission mode.

Click **Update automatically** or **Update manually**. See step 6 for the descriptions of **Update automatically** and **Update manually**.

3 Click the Advanced button.

The **Screen Image: Advanced Settings** dialog appears. Set the dialog as shown below, as necessary.

- **Interruption**

Check the **No Interruptions** checkbox to prevent other computers from interrupting the projector, for example, during a presentation.

- **Window Display**

Select the **Place in Tasktray at the start of transmission** checkbox to iconify the **Network Utility** and place it in the computer's tasktray when transmission initiated.

To display the window, double click this icon, or right click and select **Open** from the popup menu. Even with the **Network Utility** window minimized, you can use the pop-up menu to stop or resume transmission as described in step 4 and later.

- **Transmission Mode (Image)**

Selecting **High quality** improves the quality of the projected image, but lowers communication speed. Selecting **High speed** has the opposite effect.

- **Transmission Mode (Sound)**

Check the **Transmit sound to a projector (Only when connected with one projector)** checkbox to transmit the sound being played on a computer to the projector. Note: The sound can be sent when only one projector is connected.

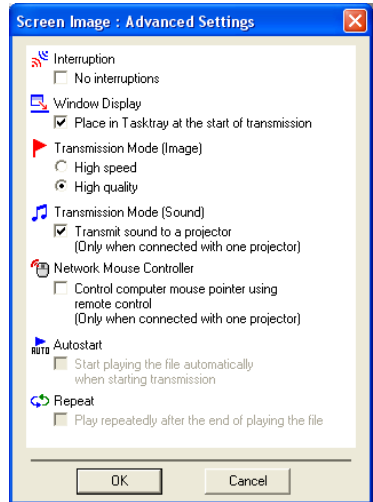

- **Network Mouse Controller**

Check the **Control computer mouse pointer using remote control (Only when connected with one projector)** checkbox to control computer mouse pointer with **Mouse control** button, **PAGE+** button, **PAGE -** button, **L-CLICK** button and **R-CLICK** button of the projector's remote control.

Note 1: This function is available when only one projector is connected to computer.

Note 2: When you use the Network Mouse Controller function, do not connect the mouse remote control receiver to your computer. The function will fail to operate properly.

4 Select the Transmission Image you wish the projector to display.

Select Desktop

The computer screen image is transmitted as-is.

Select application window

Select a running application (e.g. Microsoft® PowerPoint®), and send that application's window only.

The desktop and a list of running applications are displayed. Select the desired application from this list. (If the desired application is not on the list, launch it. Note that if too many applications are running, it will consume the computer's resources, which could slow communication speed.)

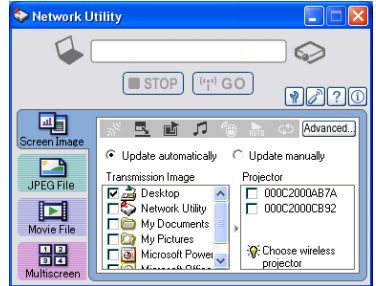

5 Select the projector to be transmitted.

A list of the names of the projectors you can use will appear. (If a projector's name is not specified, its ID will be displayed instead.) Select the checkbox of the projector you wish to transmit to from this list. Then icon  is displayed on the projector's screen for a few seconds. It is possible to select up-to four projectors.

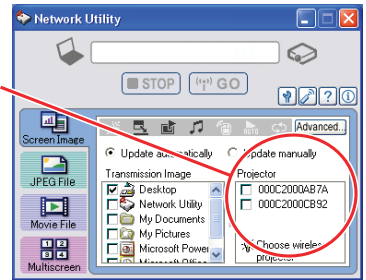

Network/
USB memory

6 Click the button.

When "Update automatically" is selected in step 2

Screen images are sent consecutively after the  button is clicked. Besides, the sound being played on a computer can be sent to the projector.

When "Update manually" is selected in step 2

A single screen image is sent when the  button is clicked.

7 To halt transmission from Update automatically, click the button.

If the **Network Utility** icon has been placed in the tasktray, double click the icon to display the window, then halt transmission, or right click the icon, and halt transmission.

Using the Network Utility (Continued)

Notes

- It may not be possible to transmit the images from a movie player or other video applications.
- When using “**Update automatically**”, the transmitted image refresh rate depends on the performance of the computer you are using and the surrounding radio wave environment.
- The projector screen may have a few differences from the computer screen.
- If you selected application window in step ④, if that application is not active (in use), the image may not be correctly displayed by the projector.
- The projector ID is the MAC address of the wired LAN inserted into the projector.
- Playing contents protected by copyright is not supported.
- To transmit sound, press the  button then launch the application that plays the contents including the sound. When you operate the projector using Windows Vista® or Windows® 7, “**Switching audio play device**” window may be displayed after pressing the start button of Network Utility. If this window is displayed, follow the instruction to switch the audio play device, and then launch the application that plays the contents including sounds.
- If no sound can be heard from the computer though the connection is stopped, re-launch the application that plays the contents including the sound.
- Transmission may not be available depending on the sound type.
- Sound cannot be transmitted if multiple projectors are selected.
- The audio signals transmitted by a computer become mono.
- **Network Mouse Controller** function may not work properly depending on the network condition.

■ Displaying a JPEG image saved on a computer via the projector

① Launch the Network Utility software application.

The **Screen Image** transmission mode window appears on the computer’s screen.

② Click the JPEG File icon .

The Network Utility window changes to **JPEG File** transmission mode.

③ Click the **Browse** button, and select the file to send.

Clicking the **Browse** button displays the **Open** dialog box. Select the file to send, then click the **Open** button.

The selected file is added to the pull-down list in the **Network Utility’s Transmission File** field.

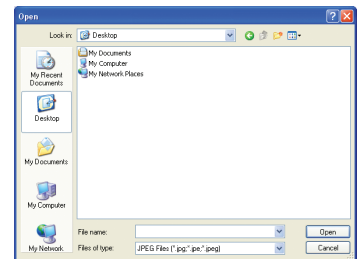
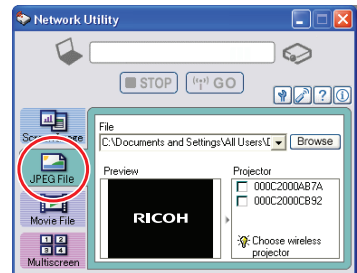

4 Select the file to be sent from the pull-down list of the Transmission File field.

Click the **Transmission File** field's  button to display the pull-down list. Select the file to be sent from this list.

A thumbnail of the selected file appears in the **Preview** box. The file displayed here will be transmitted.

Step 3 can be skipped.

The way that drag and drop the file to be sent from the desktop or Windows Explorer into the **Preview** box is also available. In this case as well, the selected file is added to the file pull-down list **Transmission File** field's.

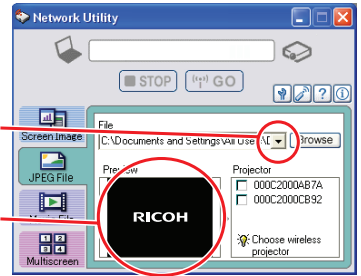

5 Select the projector to be transmitted.

A list of the names of the projectors you can use will appear. (If a projector's name is not specified, its ID will be displayed instead.) Select the checkbox of the projector to be transmitted to from this list. Then icon  is displayed on the projector's screen for a few seconds.

It is possible to select up-to four projectors.

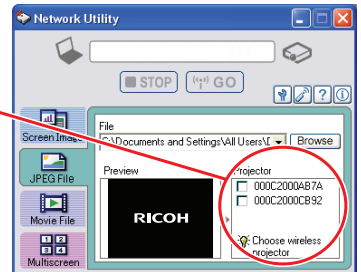

6 Click the button.

The selected file's image is displayed by the projector.

Notes

- Only one file can be sent at a time. To send another file, repeat steps 4 and 6.
- Selecting a file by drag and drop may not be available with Windows Vista® and Windows® 7.

■ Displaying a video file saved on a computer via the projector

1 Launch the Network Utility software application.

The **Screen Image** transmission mode window appears on the computer's screen.

2 Click **Movie File** .

The **Network Utility** window changes to **Movie File** transmission mode.

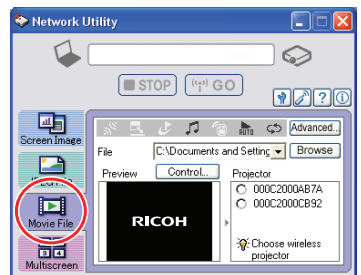

Using the Network Utility (Continued)

3 Click the Advanced button.

The **Movie file: Advanced Settings** dialog appears. Set the dialog as shown below, as necessary.

- **Interruption**

Check the **No Interruptions** checkbox to prevent other computers from interrupting the projector, for example, during a presentation.

- **Transmission Mode (Sound)**

Check the **Transmit sound to a projector (Only when connected with one projector)** checkbox to transmit the sound being played on a computer to the projector.

- **Autostart**

Check the **Start playing the file automatically when starting transmission** checkbox to automatically start playing the video file when connecting to the projector.

- **Repeat**

Check the **Play repeatedly after the end of playing** checkbox to automatically repeat from the beginning when the file reaches the end.

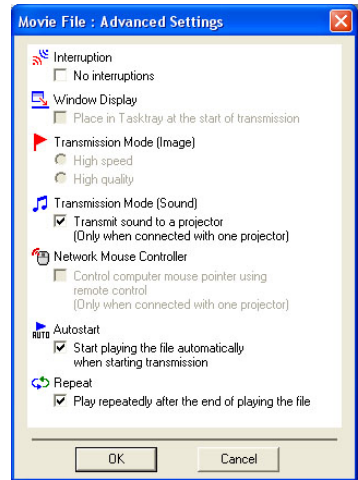

4 Click the Browse button and select the file to send.

Clicking on the **Browse** button displays the **Open** dialog box. Select the file to send then click the **Open** button.

The selected file is added to the pull-down list in the **Network Utility's Select file** field.

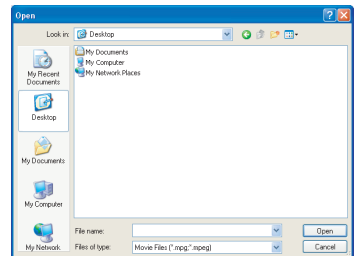

5 Select the file to send from the pull-down list of the Transmission File field.

Click the **Transmission File** field's button to display the pull-down list. Select the file to send from this list.

A thumbnail of the selected file appears in the **Preview** box. The file displayed here will be transmitted.

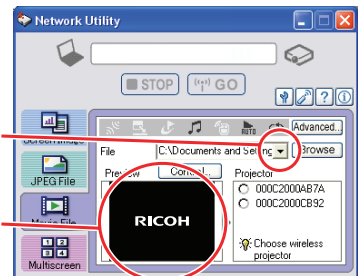

Step 4 can be skipped.

The way that drag and drop the file to send from the desktop or Windows Explorer into the **Preview** box is also available. In this case as well, the selected file is added to the pull-down list.

Note

- You may not select a file by drag and drop with Windows Vista® and Windows® 7.

6 Select the projector to transmit to.

A list of the names of the projectors you can use will appear. (If a projector's name is not specified, its ID will be displayed instead.) Select the checkbox of the projector to be transmitted to from this list. Then icon  is displayed on the projector's screen for a few seconds.

It is possible to select only one projector.

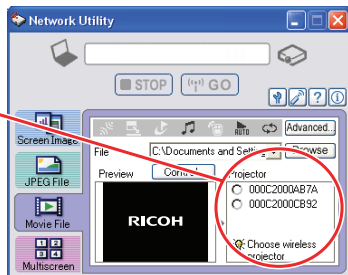





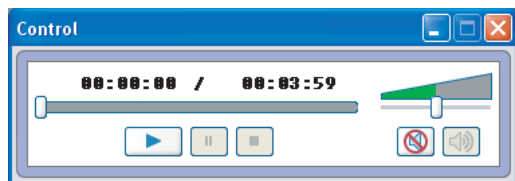

7 Click the GO button.

The selected file's image is displayed by the projector and the Control window appears as well.

8 Play the video file via the Control window.



The function of each button and box is as follows:

- | | | |
|---|----------------------------|--|
|  | (Current position): | Indicates the playing position. Dragging the slider can move the playing position. |
|  | (Play): | Starts playing the video file. |
|  | (Freeze): | The picture is paused. |
|  | (Stop): | Stops playing the video file. |
|  | (Volume): | Adjusts sound volume contained in the video file. |
|  | (Mute): | Cuts off picture and sound contained in the video file. |
|  | (Release mute): | Restores picture and sound contained in the video file. |

Notes

- Only one file can be sent at a time. To send another file, repeat steps 5 and 7.
- MPEG/AVI/ASF/WMV files can be transmitted.
- Additional software may be required to play MPEG2 or ASF files.
- The update speed of the transmitted file depends on your computer's performance and the surrounding radio environment.
- The projector ID is the MAC address of the wired LAN mounted on the projector.
- The audio signals transmitted by a computer become mono.
- Playing contents protected by copyright is not supported.

Using the Network Utility (Continued)

■ Displaying computer's screens via projectors using the Multiscreen function

1 Launch the Network Utility software application.

The **Screen Image** transmission mode window appears on the computer's screen.

2 Click the Multiscreen icon

The **Network Utility** window changes to **Multiscreen** transmission mode.

3 Select Transmission mode.

Click **Update automatically** or **Update manually**. See step 7 for the descriptions of **Update automatically** and **Update manually**.

4 Click the Advanced button.

The **Multiscreen: Advanced Settings** dialog appears. Set the dialog as shown below, as necessary.

• Window Display

Select the **Place in Tasktray at the start of transmission** checkbox to iconify the **Network Utility** and place it in the computer's tasktray when transmission initiated.

To display the window, double click this icon, or right click and select **Open** from the pop-up menu. Even with the **Network Utility** window minimized, you can use the pop-up menu to stop or resume transmission.

• Transmission Mode (Image)

Selecting **High quality** improves the quality of the projected image, but lowers communication speed. Selecting **High speed** has the opposite effect.

• Transmission Mode (Sound)

Check the **Transmit sound to a projector (Only when connected with one projector)** checkbox to transmit the sound being played on a computer to the projector.

Note: The sound can be sent when only one projector is connected.

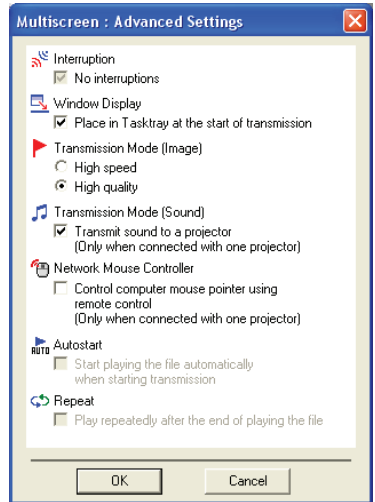
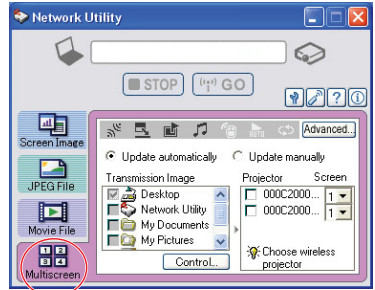

■ Note

- The multi screen function cannot be used with Windows 7.

- **Network Mouse Controller**

Check the **Control computer mouse pointer using remote control (Only when connected with one projector)** checkbox to control computer mouse pointer with **Mouse control** button, **PAGE+** button, **PAGE -** button, **L-CLICK** button and **R-CLICK** button of the computer's remote control.

Note 1: This function is available when only one projector is connected to computer.

Note 2: When you use the Network Mouse Controller function, do not connect the mouse remote control receiver to your computer. The function will fail to operate properly.

5 Arrange the virtual display layout.

- ① Clicking the **Display Properties** button in the Control window displays the window for screen display settings.
- ② Right click the desired virtual display (Ricoh DPJ Secondary Display Driver) and select **Attached** from the popup menu.
- ③ Allocate screen displays by drag and drop of monitor icons.
- ④ Click **OK** button in the window for screen display settings, then the **Screen Layout** in the Control window will be updated accordingly.

When you check **Switch to the last screen settings when using next time** the virtual display layout that has been set will be memorized upon exit from **Network Utility** and it will switch to the screen settings the next time you use the Multiscreen feature.

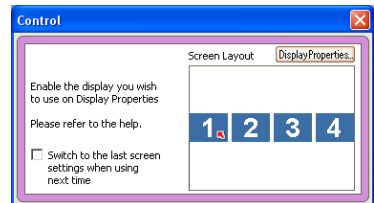
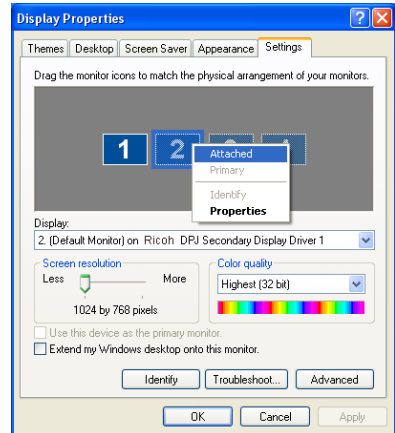

Using the Network Utility (Continued)

6 Select the projector to transmit to.

A list of the names of the projectors you can use will appear. (If a projector's name is not specified, its ID will be displayed instead.) Check the checkbox of the projector you wish to transmit to from this list. And select the virtual display number that you wish to transmit to from the pull-down list in the **Screen** box. Then  icon marked with a number (corresponding to the screen number) is displayed on the selected projector's screen for a few seconds. Up-to four projectors are available to select.

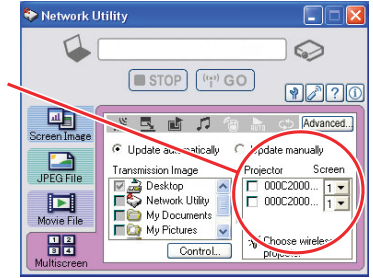

7 Click the button.

When “Update automatically” is selected in step 3

Screen images are sent consecutively after the  button is clicked. Besides, the sound being played on a computer can be sent to the projector.

When “Update manually” is selected in step 3

A single screen image is sent when the  button is clicked.

● Multiscreen Usage Examples

Example 1)

While projecting image data sent from your computer on a screen, you can also display the other image data such as a presenter script on your computer so that you can give a presentation without showing any image data which you do not wish to let other participants see.

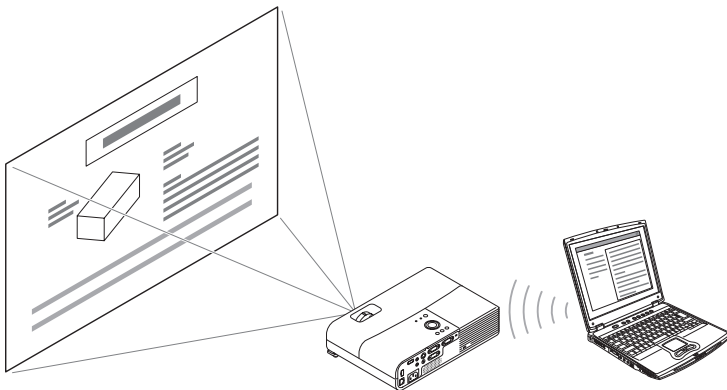

Example 2)

Using only a single computer, you can make an effective presentation by displaying different image data stored in the computer via multiple projectors (up to 4 projectors).

[When using 2 projectors]

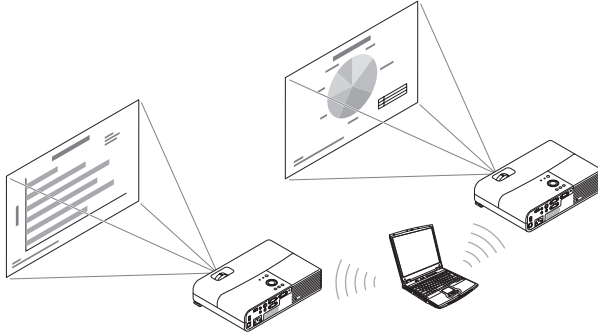

[When using 4 projectors]

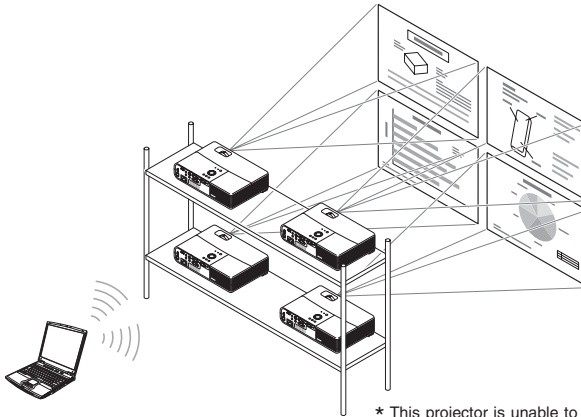

* This projector is unable to display a divided single image in large size by combining each display sent by multiple projectors.

Notes

- The figures shown here are illustrated as projectors are connected to a computer via wireless LAN, however, this also applies for the connection via wired LAN.
- Note the characteristics such as the brightness or the color tint of the projected image may vary depending on each projector. This is not a malfunction.

CAUTION

When you use multiple projectors with Multiscreen feature, make sure to leave sufficient space (more than 70 cm) between projectors. If you set the projector near the air exhaust of the other projector, it may cause damage to other units due to heat.

Using the Network Utility (Continued)

■ Notes

- It may not be possible to transmit the images from a movie player or other video applications.
- When using “**Update automatically**”, the transmitted image refresh rate depends on the performance of the computer you are using and the surrounding radio wave environment.
- The projector screen may have a few differences from the computer screen.
- The projector ID is the MAC address of the wired LAN inserted into the projector.
- Playing contents protected by copyright is not supported.
- To transmit sound, press the  button then launch the application that plays the contents including the sound. When you operate the projector using Windows Vista® or Windows® 7, “**Switching audio play device**” window may be displayed after pressing the start button of Network Utility. If this window is displayed, follow the instruction to switch the audio play device, and then launch the application that plays the contents including sounds.
- If no sound can be heard from the computer though the connection is stopped, re-launch the application that plays the contents including the sound.
- Transmission may not be conducted depending on the sound type.
- Sound cannot be transmitted if multiple projectors are selected.
- The audio signals transmitted by a computer become mono.
- **Network Mouse Controller** function may not work properly depending on the network condition.
- If you make any changes in the screen display settings of the window without launching **Network Utility**, the settings you made will be erased and not be reflected even if you check **Switch to the last screen settings when using next time** checkbox.
- For multiscreen function, the images on the computer’s desktop can only be selected to transmit for display. Note that the application software are not available to select as transmission images.

■ Easy Connect utility

This feature allows users to easily connect the projector to a computer over wireless networks, without making **Wireless LAN settings** using **Network Utility**.

Launch the **Network Utility** software application and click the Tool button  to bring up the **Wireless LAN Settings Utility** dialog box. Select a desired connection mode in this dialog box.

● How to set up with [Simple 1:1 connection]

• Setting on the projector

- 1 Turn the projector power on.
- 2 Switch the input to Network.
- 3 Press the  button on the projector control panel.

• Setting on the computer

4 Launch the Network Utility software application.

When the **Network Utility** launches, the **Screen Image** transmission mode window appears on the computer screen.

5 Click the Tool button .

The **Wireless LAN Settings Utility** dialog box appears.

6 Select [Simple 1:1 connection] then click OK.

The connection starts up.

When a connection confirmation message appears, proceed as instructed in the message.

7 When the connection is complete, the computer screen image is transmitted.

If the transmission does not start, uncheck the **Confirm and immediately transmit screen image** checkbox.

■ Notes

- This operation is allowed only when the Transmission mode is set to **Ad hoc** in the projector's wireless LAN settings.
- The operation procedure of the projector setting and the computer setting can be altered without affecting the connection setup, assuming the operation on each side is complete within 60 seconds.
- Be sure to use Network Utility version 1.0 or later.

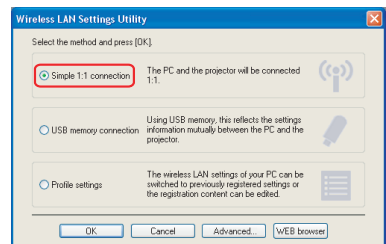
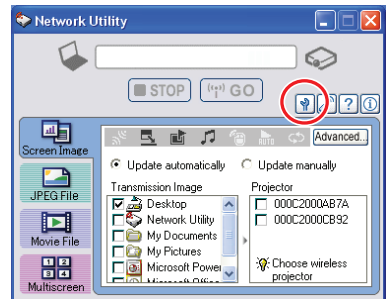

Using the Network Utility (Continued)

● How to set up with [USB memory connection]

Set up wireless LAN using a commercial USB memory device. For USB devices whose operation has been verified, please contact your sales representative.

1) Copying the computer settings to the projector

• Setting on the computer

❶ Insert the USB memory device into the USB terminal slot on the computer.

❷ Click the Tool button  of the Network Utility to bring up the Wireless LAN Settings Utility dialog box. Select [USB memory connection] and click OK.

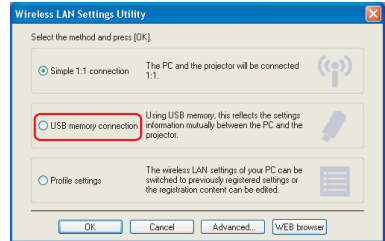

The dialog box for [USB memory connection] appears.

❸ Select [Projector settings] and click OK, then enter the required setting items and click OK.

The setting information is saved to the USB memory device.

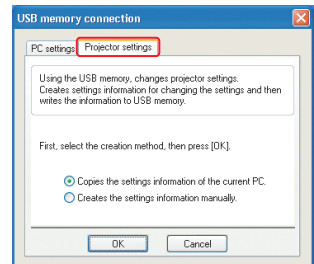

❹ Unplug the USB memory device from the computer.

To unplug the USB memory device, follow the instructions in the user's manual supplied with the USB memory device or the computer.

• Setting on the projector

❺ Turn the projector power on.

❻ Switch the input to Network.



❼ Insert the USB memory device into the projector.

A message appears, notifying that the projector settings have been changed.

❽ The projector name or the projector ID (MAC address of wired LAN) will be displayed in the projector's list in the Network Utility window.

2) Modifying the computer settings using the projector settings

• Setting on the projector

- ① Turn the projector power on.
- ② Switch the input to Network.
- ③ Press the MENU button twice, then select Easy Connect (USB memory) in Network Utility settings from the Setting display (2) menu and press the  button.
- ④ When a confirmation window appears, insert the USB memory device into the projector.
- ⑤ Click Yes then press the  button.
The wireless LAN settings are saved to the USB memory device. When successfully saved, a message appears.
- ⑥ Unplug the USB memory device.

• Setting on the computer

- ⑦ Launch the Network Utility software application.
- ⑧ Insert the USB memory device into the computer.
- ⑨ After a confirmation message appears, make settings.

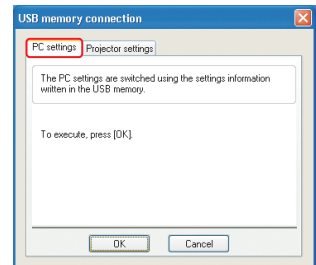

- ⑩ When the setting is complete, the projector name of the connected projector or the projector ID (MAC address of wired LAN) is displayed in projector's list in the Network utility window.

■ Note

- This operation is allowed only when the Transmission mode is set to **Ad hoc** in the projector's wireless LAN settings. Be sure to use Network Utility version 1.0 or later.

Using the Network Utility (Continued)

● How to use [Profile settings]

This feature allows the user to save the computer's wireless LAN settings. This feature is useful when you need to change wireless LAN settings according to where you use.

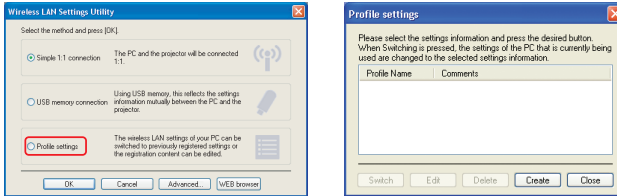

● Advanced setting

This feature allows the user to set details for Easy Connect settings. Make the following settings as required in this dialog.

● Registering profile automatically

Check this checkbox to automatically register the settings of the Easy Connect as profile setting data.

● Switching settings automatically at start-up

Check this checkbox to automatically switch to the last used wireless LAN settings when launching the Network Utility.

● WEB browser

Where the computer and the projector are connected over the network, bring up the window of Projector Configuration Tool by pressing the **WEB browser** button.

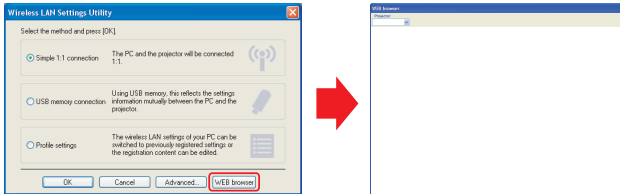

■ Precautions

- If the page is not displayed correctly, re-select the projector.
- When the network settings are changed, the network connection is disconnected. If you wish to reconnect, set up the computer again.

■ Precaution

- The simple 1:1 connection, the USB memory connection and the profile setting may not work normally depending on the type of the wireless LAN adapter and the wireless LAN embedded computer. When such a case arises, use the Network Utility menu to make necessary wireless LAN settings manually.

■ Operating the projector

This function can be used with any projector input.

1 Launch the Network Utility software application.

The **Screen Image** transmission mode window appears on the computer's screen.

2 Click the Remote Control button.

The **Remote Control** window appears.

As the **Network Utility** window is still displayed, you can operate the projector via the **Remote Control** window, while using the Network Utility's functions.

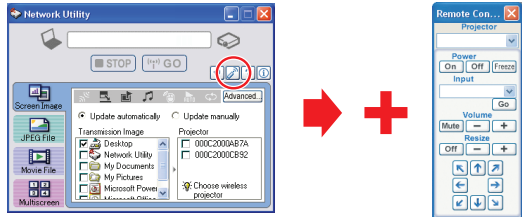

While it is possible to use this function merely to operate the projector, closing the **Network Utility** also closes the **Remote Control** window.

3 Select the projector to be operated.

In the **Remote Control** window, click the  button, and select the desired projector from the pull-down list. When you make a selection, the **Remote Control** window displays as shown in the right figure.

Only one projector can be selected. (It is not possible to operate multiple projectors.)

4 Click the Remote Control window's buttons.

The function of each button and box is as follows:

Power On: Turns projector power on.

Power Off: Turns projector power off.

Freeze: The picture is paused.

Input (box): Click the  button, and select the desired input from the pull-down list.

Go: Switches to the input selected in the Input box.

Mute: Cuts off picture and sound. Click again to restore picture and sound.

Volume +/-: Adjust sound volume.

Resize Off Restores the picture to its original size.

Resize +/-: Adjusts the enlargement ratio.



: Move screen (up/down/left/right/diagonal)



5 To quit, click the button on the Remote Control window.

Performing this does not close the **Network Utility** window.

To exit both the **Network Utility** and the **Remote Control**, click the  button on the **Network Utility** window.

Projecting images stored in a USB memory device

■ Playing a slide show from a thumbnail list

With **Auto. demo** set to **Off** in “**Setting slideshow options**”, data readout begins when a USB memory device is inserted and the input switches to USB memory. A list of thumbnails will then appear on the screen.

The figure below is an example of this process:

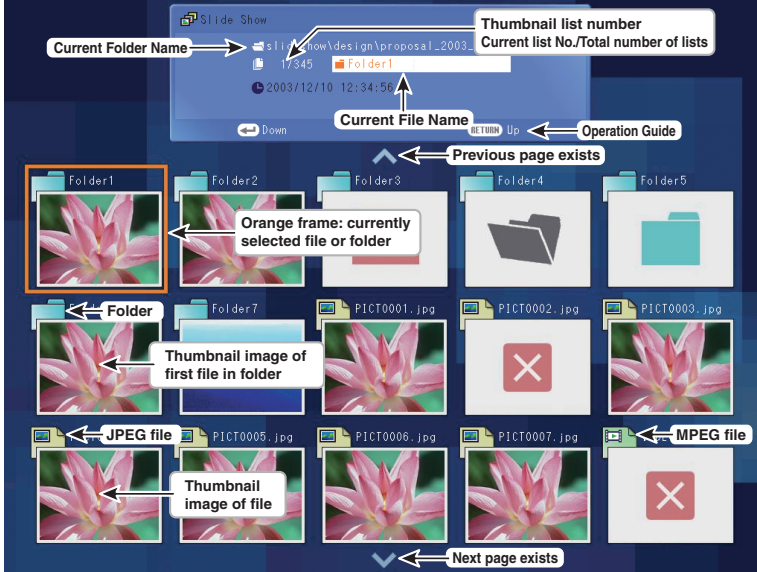

Symbols in the thumbnail list



Indicates that only folders are inside the folder.



Indicates that there is no data to be displayed in the folder.



Indicates that the first JPEG, MPEG or other file is not supported.



Indicates that an unsupported JPEG, MPEG or other file is present.



When the **Thumbnail display** is set to **Off**, the screen appears like this.

1 Plug a USB memory device.

Plug in a USB memory device according to the procedure in “Connecting USB device” p.48. The projector starts loading data from the USB memory device and displays a thumbnail list on the screen.

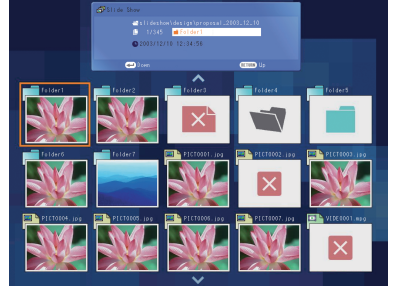

2 Searching for a target file

- Use the **▼** **▲** **◀** **▶** buttons to move the orange frame over the desired file or folder.
- If there are multiple pages of thumbnails, click the **▼** button on the bottom row to go to the next page, and the **▲** button on the top row to go to the previous page.
- To open a folder, move the orange frame to the desired folder and press the **▶** button. You can navigate down 5 levels using the same procedure. Pressing the **RETURN** button returns you to the next/other upper level folder.

For JPEG files

3 Displaying slides

- Pressing the **▶** button with a file selected displays the only images in that file in full-screen view on the screen as a slide. Pressing the **▶** button begins automatic play mode.
- To return to the thumbnail list display screen, press the **RETURN** button.

4 Changing slides

Pressing the **◀** **▶** buttons with a slide displayed changes slides.

(**◀** : previous slide; **▶** : next slide. These buttons are not available during an automatic play.)

5 Rotating a slide



Pressing the **▲** **▼** buttons with a slide displayed rotates the slide 90 degrees. The rotation information is preserved as long as you remain in the current folder.

(**▲** : Rotate left; **▼** : Rotate right. These buttons are not available during an automatic play.)



Projecting images stored in a USB memory device (Continued)

● For MPEG files

③ Displaying video

- Pressing the  button while a file is selected plays only the video image in full-screen view. Pressing the  button again pauses the video image.
- To return to the thumbnail list display screen, press the **RETURN** button.

④ Fast-forwarding and rewinding video images

Pressing the   buttons while a video image is displayed fast-forwards or rewinds the video image.

( : Fast-forward;  : Rewind)

■ Notes

- The thumbnail display and slide order are listed from the shortest file name to the longest. If two file names have the same number of characters, they are ordered numerically if numbers are used in the file name, and alphabetically otherwise.
- It is possible to give presentations without using a computer by converting presentations created with Microsoft® PowerPoint® into JPEG files using the **JPEG Conversion Tool**, and storing them on a USB memory device. [p.83](#)
Note, however, that functions such as animation effects and hyperlinks cannot be used, so the converted file should be tested before the actual presentation.
- Freeze function cannot be used during slide show or automatic play.
- A slide show is terminated when the input is switched to another.
- With some USB memory devices, the slideshow playback may stop midway. If you encounter this, use another USB memory device because the current one is not supported.
- Pressing the **GUIDE** button on the remote control with a slide or video image displayed displays the slideshow operation guide.
- When you operate the projector using the USB memory card reader/writer, up to 4 media types are supported.

How to use the JPEG Conversion Tool

The **JPEG Conversion Tool** converts JPEG files not supported by the projector, image files in other formats, Microsoft® PowerPoint® files, and other similar files into JPEG files. The JPEG files converted with this tool can be displayed by sending them using the wireless LAN [p.66](#), or saving them on a USB memory device.

■ Launching the JPEG Conversion Tool

The window shown in the figure to the right appears on the computer screen.

Drag the **Image Quality Settings** slider to the left or right to set the image quality of the file after conversion. Lower values create smaller files, but will lower the image quality. (It is not possible to restore the quality of an image after it has been lowered.)

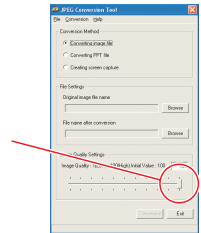

■ Converting an image file

This takes JPEG files created with compression formats not supported by the projector, for example, Windows® metafiles (wmf), and bitmapped files (bmp), and converts into JPEG files.

- (1) In the **Conversion Method** field, select **Converting image file**. (Status on launch)
- (2) In the **File settings** field, click the **Browse** button for **Original Image File Name**.

The **Open** dialog box appears.

- (3) In the **Open** dialog box:
 - (a) Specify the location of the file to be converted; and
 - (b) In the **Files of Type** field, click the **▼** button to select the file format. A list of files of that format appear in the **Open** dialog box.
- (4) In the **Open** dialog box, select the file to convert, then click the **Open** button.
- (5) In the **JPEG Conversion Tool** window, in the **File settings** field, select **Browse** for **File name after conversion**. The **Save As** dialog box appears.

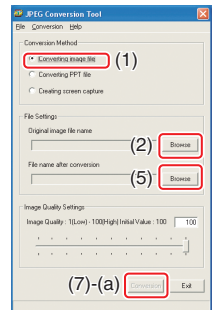

- (6) In the **Save As** dialog box:
 - (a) Specify the location in which to save the converted file;
 - (b) Enter a file name of up to 8 characters in the **File Name** field; and
 - (c) Click the **Save** button.
- (7) (a) In the **JPEG Conversion Tool**, click the **Conversion** button.
 - (b) The resolution selection dialog box appears. Select a desired resolution and click the **OK** button.
 - (c) A confirmation dialog box opens. Click **Yes**.
The computer converts the file. When it finishes a message appears informing you that “a JPEG file has been created”.

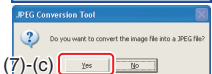
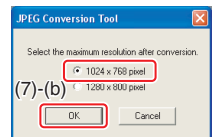
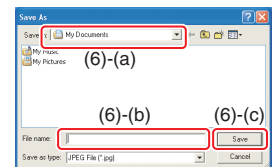
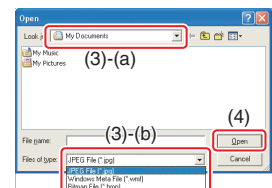

Network/
USB memory

How to use the JPEG Conversion Tool (Continued)

■ Converting files created with Microsoft® PowerPoint®

This process provides presentations without using a computer by converting presentation files created with Microsoft® PowerPoint® into JPEG files, storing them on a USB memory device, and displaying them in a slide show.

- To use this conversion mode, Microsoft® PowerPoint® must be installed on the computer.
- Only static images are supported by this process. Animation and audio are not supported.

Presentation files created with Microsoft® PowerPoint® usually consist of several slides. For this reason, the tool creates a folder with the name specified in step (5), below, and file for each slide is created in the folder (starting with slide001.jpg).

(1) In the **Conversion Method** field, select **Converting PPT file**.

(2) In the **File settings** field, click the **Browse** button for **PPT File Name**.

The **Open** dialog box appears.

(3) In the **Open** dialog box:

- (a) Specify the location of the file to be converted; and
- (b) Select the PowerPoint® presentation file to convert, then click the **Open** button.

(4) In the **JPEG Conversion Tool** window, in the **File settings** field, click the **Create** button for **New folder name**.

The **Folder create** dialog box appears.

(5) In the **Folder create** dialog box, in the **Folder Name of document** of document field, specify a folder name of 12 characters or less.

(6) In the **Folder create** dialog box, click the **Selection** button. The **Browse for Folder** dialog box appears.

(7) In the **Browse for Folder** dialog box:

- (a) Specify the location in which to save the folder; and
- (b) Click the **OK** button.

(8) In the **Folder create** dialog box:

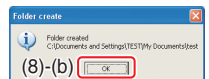
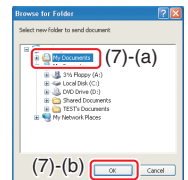
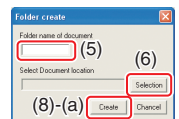
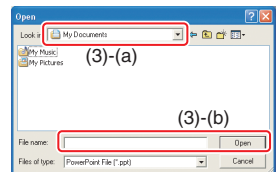
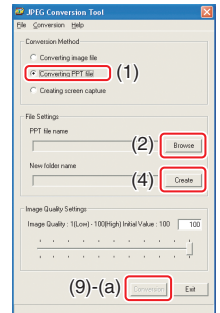

- (a) Click the **Create** button. A confirmation dialog box appears;
- (b) Click the **OK** button.

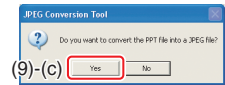
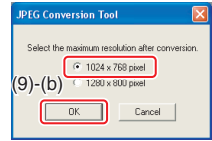

- (9) (a) In the **JPEG Conversion Tool** window, click the **Conversion** button.
- (b) The resolution selection dialog box appears. Select a desired resolution and click the **OK** button.
- (c) A confirmation dialog box opens. Click **Yes**.
The computer begins to convert the file. When it finishes, a message appears informing you that “a **JPEG file has been created**”.



■ Making a presentation with converted JPEG files

- (1) Copy the folder created by the **JPEG Conversion Tool**, and/or its contents, onto a USB memory device.
- (2) Use step ① in “**Playing a slide show from a thumbnail list**” **p.80** to display a list of thumbnails.
- (3) Follow the instructions in step ② in “**Playing a slide show from a thumbnail list**” **p.80** to find the thumbnail of the first slide, Slide001.jpg, and move the orange frame to it. (Select Slide001.jpg)
- (4) Press the  button on the remote control. An enlarged view of the first slide appears on the screen. This starts the presentation.
- (5) To continue to the next slide, click the remote control's  button. To go back to the previous slide, click the  button.

How to use the JPEG Conversion Tool (Continued)

■ Creating a screen capture and converting it into a JPEG file

This function saves the current computer screen as a JPEG file.

- (1) In the **Conversion Method** field, select **Creating screen capture**.
- (2) In the **File settings** field, click the **Browse** button for **File name after conversion**.
The **Save As** dialog box appears.
- (3) In the **Save As** dialog box:
 - (a) Specify the location in which to save the converted file;
 - (b) Enter a file name of up to 8 characters in the **File Name** field; and
 - (c) Click the **Save** button.
- (4) (a) In the **JPEG Conversion Tool** window, click the **Conversion** button.
 - (b) The resolution selection dialog box appears. Select a desired resolution and click the **OK** button.
 - (c) A confirmation message appears. Click **Yes**.
The computer creates a screen capture, and converts it into a JPEG file in the specified location. When it is finished, a message appears to tell you that “a JPEG file has been created”.

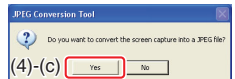
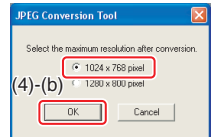
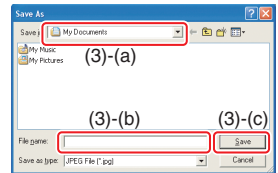
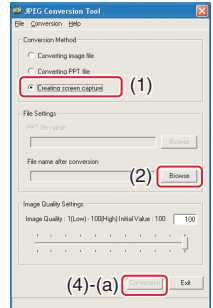

■ Note

- The selected resolution in the dialog box will be the maximum resolution of the converted image file. Specify the resolution in accordance with your projector's resolution.

Setting up the projector using a Web browser

■ How to use the “Projector Configuration Tool”

The “**Projector Configuration Tool**” uses the Web server features of the projector to set up the projector using the network.

When using the “**Projector Configuration Tool**”, set up the Network connecting the projector and the computer.

1 See “**Checking the projector status**” [p.60](#) to display information on the screen and write down the IP address.

2 Invoke Internet Explorer.

Internet Explorer Ver. 6.0, Ver. 7.0 or Ver. 8.0* is recommended. Enable the Javascript functions.

* Ricoh does not guarantee the operation for later versions.

3 In the address bar, enter the IP address “**http://xxx.xxx.xxx.xxx/**” recorded in step **1** above.

The Web browser will then display the following page.

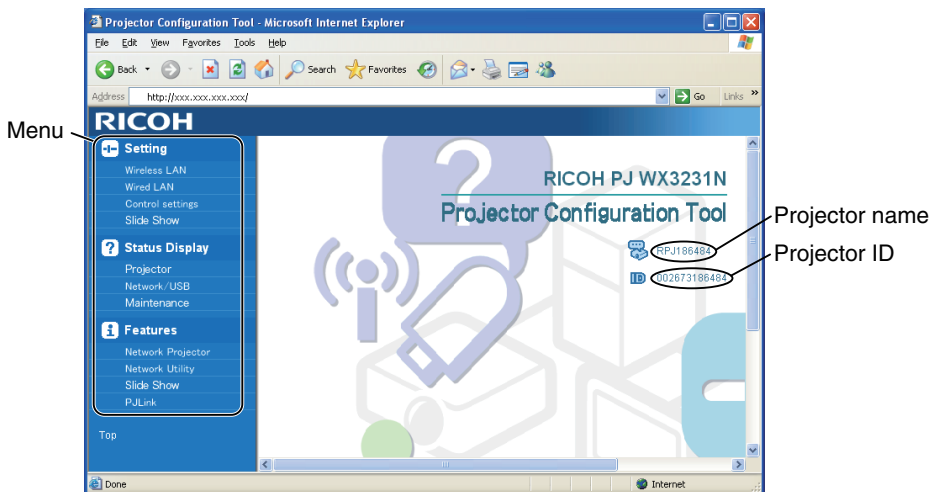

Note: If you use a proxy server, do not enable the proxy when accessing the above IP address.

When the wireless LAN is set to use Ad hoc mode, use the **WEB browser** function in the **Wireless LAN Settings Utility** dialog box of Network Utility.

■ Note

- This function can be enabled using the **WEB Browser** function in the **Wireless LAN Settings Utility** dialog box of Network Utility without specifying the URL into the browser's address bar.

Setting up the projector using a Web browser (Continued)

4 Select items from the menu on the left.

- Settings:** Make settings for the Network or USB memory input menu.
- Status Display:** Verify the projector state.
- Features:** Shows the functions available with the Network or USB memory.
- Top:** Returns you to the top page.

● Details on major items

● Settings

When **Browser authentication** has been set to **On**, access to the setup page requires the input of the password.

The following settings are available for [**Wireless LAN**], [**Wired LAN**], [**Control settings**] and [**Slideshow**].

- The items displayed on the screen can be set.
- Enter individual items and press the **Execute** button to update their setting.

● Status display

Displays some states of the projector.

Projector: Displays the contents of status display in the Setting display.

Network/USB: Displays the contents of status display of the Network or USB memory input in the Setting display (2).

Maintenance: Describes an error if it occurs, for example, when the lamp has blown.

■ Notes

- Clicking the ? button opens a popup help window.
- The security items such as “**Remote control**” and “**Browser authentication**” cannot be set.



Lamp replacement

A lamp is a consumable item. If used for extended periods, images will appear dark, and the lamp could burn out. This is characteristic of a lamp, and is not malfunction. (The lifetime of the lamp depends on condition of use.) If this happens, replace it with a new one.

WARNING

- **If the projector is mounted on the ceiling, it is strongly recommended that you contact your sales representative when the lamp has to be exchanged. Do not attempt to replace the lamp by yourself.**

If you uncover the lamp while the projector is mounted on a ceiling, there may be a danger of damage from falling pieces of glass if the lamp is broken, resulting in possible injury. In addition, working at high elevations can also be potentially hazardous. Do not attempt to replace the lamp by yourself.

- **Always use lamp “PJ Replacement Lamp Type1” (sold separately) when replacing the lamp.**

Using a lamp other than the one specified may cause a malfunction or damage to the unit due to the difference in the connector shape or the lamp rate.

CAUTION

- **If you have been using the projector, the lamp will be very hot, and may cause burn injuries.**
Wait 1 hour or longer for the lamp to cool before replacing it.
- **If the lamp should break, please handle with care to avoid injury due to broken pieces and contact your sales representative for repair service.**

Lamp replacement (Continued)

1 Unplug power cord.

2 Wait until lamp is sufficiently cooled.

Wait for at least 1 hour.

3 Remove the outer lamp cover.

To remove the outer lamp cover, loosen the screw on the side of the projector, and then slide the cover out and up (as shown in the illustration).

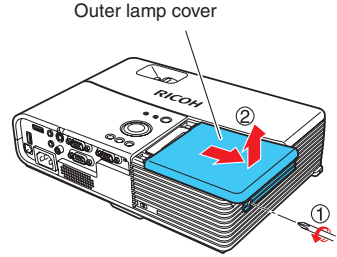

4 Remove the inner lamp cover.

To remove the inner lamp cover, fully remove both screws, and then lift the cover (as shown in the illustration). Be careful not to loose the screws.

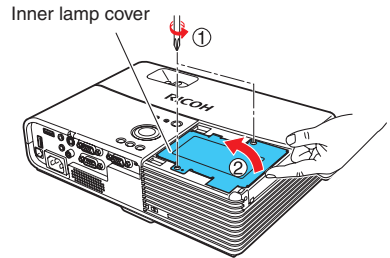

5 Pull out the lamp.

Loosen the 3 lamp locking screws, pull up the handle, and press the tab to remove the lamp.

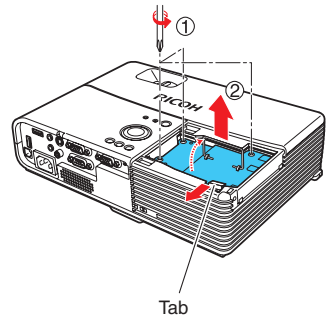

6 Mount the new lamp.

Align the orientation, press down the new lamp until the bottom is reached. Then lock it in place using the 3 lamp locking screws.

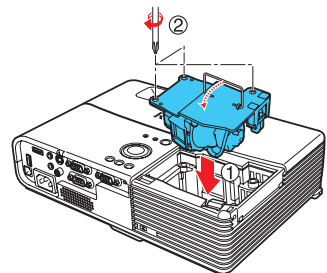

7 Replace the inner lamp cover.

Reattach both screws removed in step 4. Tighten the screws until the inner lamp cover is fully immobile.

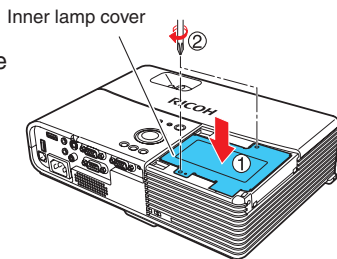

8 Replace the outer lamp cover.

Reseat the outer lamp cover by sliding it in the direction of the arrows (as shown in the illustration), and then tighten the screw loosened in step 3. Tighten the screw until the outer lamp cover is fully immobile. (The outer lamp cover must be attached.)

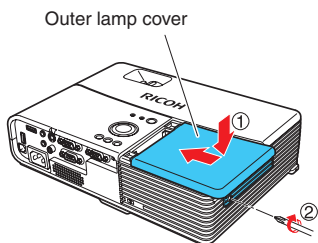

9 Reset the lamp time.

See the lamp's manual for instructions on resetting the lamp time.

Notes and Precautions

- The [Lamp time] item in the **Status display** menu indicates the time of lamp use. (Use it as a rough estimate or guide for lamp life.) [p.45](#)
- Please replace the lamp after 2000 hours of use if [Lamp power] in the **Default setting 1** menu is set to [Standard], or after 3000 hours of use if [Lamp power] in the **Default setting 1** menu is set to [Low]. [p.42](#)
- There may be cases where the lamp stops working before the above mentioned period expires or before the replacement message is displayed.
- Attach the outer lamp cover correctly so that it is secure and not loose. If it is not attached correctly, the projector may fail to turn on or the lamp may fail to come on.
- Always replace the lamp with a new one.
- The lamp is made out of glass. Do not touch the glass surface with your bare hands, bang it, or scratch it. Since dirt, jolts, scratches and other similar particles may affect the lamp.

● About lamp replacement messages

- The lamp replacement message displays an appropriate period based on the use period selected in [Lamp power].
- When the replacement time approaches, “**The lamp life is ending. Please change the lamp.**” message is displayed each time the power is turned on. The display disappears when you press the  button.

Used Lamps

This projector's lamp contains trace amounts of environmentally harmful inorganic mercury. Be careful not to break used lamps, and dispose of them in accordance with local regulations or contact your sales representative.

Air filter cleaning

The air filter prevents dust and debris from getting inside the projector. Never run the projector with the filter removed. It is recommended that you clean the air filter regularly.

- The message “**Check the air filter for dirt.**” is displayed every 100 hours. (Once the usage time exceeds 100 hours, the message is displayed for about 30 seconds the first time the power is turned on and an image is displayed. The message will disappear with any operation.)
- Check the filter and if any debris is found, use the following cleaning procedure.

WARNING

- **Request cleaning and maintenance of a ceiling-mounted unit from your sales representative.**

Attempting to clean or replace the filter in a high location by yourself may cause you to fall, resulting in injury.

1 Unplug power cord.

2 Remove the air filter.

Pull out the air filter by holding the release knob with your fingers as shown in the figure.

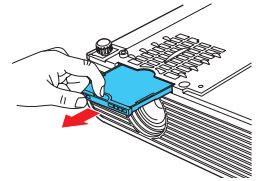

3 Clean the filter.

Carefully remove the dust and dirt from the air filter with a vacuum cleaner or the like.

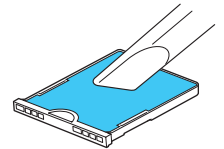

4 Replace the air filter.

Insert the air filter firmly until you hear a click.

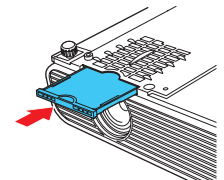

Notes

- When dirt and dust build up in the air filter, the air circulation inside the projector is affected and the internal temperature will rise, causing the projector to stop working or malfunction.
- Push the air filter fully in. If the projector is used with the air filter only partially inserted, dust and dirt will enter the interior and this could cause the projector to stop working or break down.
- If you wash the air filter with water, make sure you dry it thoroughly before replacing it.
- If the air filter becomes damaged, replace it. Contact your sales representative for a new filter. If you continue to use the projector when its filter is damaged, dust and dirt will enter the interior and this could cause the projector to stop working or break down.

Lens and main unit cleaning



WARNING

- **Request cleaning and maintenance of a ceiling-mounted unit from your sales representative.** Attempting to clean the unit or replace the lamp in a high location by yourself may cause you to fall, possibly resulting in injury.

■ Lens cleaning















- Clean the lens with a commercially available blower and/or lens cleaner.
- The lens is easily scratched, so do not rub it with hard objects, or strike it.

■ Main unit cleaning

- Always unplug the power cord before cleaning the main unit.
- Wipe dirt off the main unit gently using a soft cloth.
- Do not wipe the main unit with a damp cloth. Doing so may allow water to get inside, resulting in possible electric shock or unit failure.
- Do not use benzene, thinner or other similar chemical solutions as they may deform or discolor the unit or damage the paint surface.
- Do not use a chemically saturated cloth.

Trouble indications

The indicator illuminates and a beep sounds to inform you of internal abnormalities.

<p>LAMP TEMP ON/STANDBY</p> <p>○ ○  (OFF)</p>	<p>No power</p> <p>⇒ Problem with projector</p> <ul style="list-style-type: none"> • Unplug the power cord, and contact your sales representative.
<p>LAMP TEMP ON/STANDBY</p> <p> ○  (Red flashing) (Red lit)</p> <p>or</p> <p>LAMP TEMP ON/STANDBY</p> <p>● ○  (Red lit) (Red lit)</p>	<p>Lamp went out during use, or won't come on</p> <p>⇒ Lamp temperature is high so that it is difficult to turn on, the lifetime of the lamp has ended or the projector is malfunctioning.</p> <ul style="list-style-type: none"> • Unplug the power cord and wait for a short while, then turn the power back on. • If a lamp burns out, replace it with a new one.
<p>LAMP TEMP ON/STANDBY</p> <p>○   (Red flashing) (Red lit)</p>	<p>Power went out during use</p> <p>⇒ Internal overheating, or the outside temperature is too high.</p> <ul style="list-style-type: none"> • Make sure the projector is placed so that the air intake and exhaust are not blocked. • Unplug the power cord and wait for a short while, then turn the power back on. <p>*The  icon will appear before the power goes out.</p>
<p>LAMP TEMP ON/STANDBY</p> <p>○   (Green flashing) (Red lit)</p>	<p>Power went out during use</p> <p>⇒ Problem with internal cooling fan.</p> <ul style="list-style-type: none"> • Unplug the power cord, and contact your sales representative. <p>*The  icon will appear before the power goes out.</p>
<p>LAMP TEMP ON/STANDBY</p> <p> ○  (Orange flashing) (Red lit)</p>	<p>Power went out during use, or power won't come on</p> <p>⇒ The lamp cover is not properly attached.</p> <ul style="list-style-type: none"> • Unplug the power cord, and reattach the lamp cover. p.92
<p>LAMP TEMP ON/STANDBY</p> <p>○ ●  (Orange lit) (Red lit)</p>	<p>Power went out during use</p> <p>⇒ Problem inside the projector.</p> <ul style="list-style-type: none"> • Unplug the power cord and wait for a short while, then turn the power back on. • If the above action does not clear the problem, unplug the power cord, and contact your sales representative. <p>*The  icon will appear before the power goes out.</p>

Note

- After there is an abnormal indication, the abnormal status remains until the power cord is unplugged.

Troubleshooting

If you think something is wrong, check the followings before contacting customer service. Please see “**Trouble indications**” [p.96](#) as well.

If This Happens	Check
No power	<ul style="list-style-type: none"> • Is the power cord plugged in? Is it connected to the projector? • Is the outer lamp cover attached properly? p.92
Power goes out during use	<ul style="list-style-type: none"> • Is the ambient temperature high? p.96 • Is the air intake or air exhaust blocked? p.96
No picture	<ul style="list-style-type: none"> • Is the input source selected correctly? (When [Auto input search] is [Off]) p.42 • Did you press the input button? p.28 • Is the mute function on? p.33 • Is the brightness setting minimized? p.37 • Are the connections set up correctly? p.24 • Are all the connected devices functioning properly?
No audio	<ul style="list-style-type: none"> • Did you press the input button? p.28 • Is the mute function on? p.33 • Is the volume setting minimized? p.29 • Are the connections set up correctly? p.24 • Are all the connected devices functioning properly?
Picture not displayed correctly	<ul style="list-style-type: none"> • Is the input signal supported by the projector? p.100 p.101 • Is there something generating an abnormal video signal, for instance the video tape?
Picture blurred Part of picture out of focus	<ul style="list-style-type: none"> • Is the lens dirty? p.95 • Is the lens focus adjusted optimally? p.29 • Is the projection distance within the projector's supported range? p.22 p.23 • Is the projector's screen placement angle tilted too far? p.29 • Are the sharpness or sampling phase adjustments off? p.37 p.38
Image is dark	<ul style="list-style-type: none"> • Are the brightness or contrast adjustments off? p.37 • Is the lamp nearing the end of its service life? p.45 • Is the RGB input range set properly? p.37
Colors too light Bad shading	<ul style="list-style-type: none"> • Are the color, R-level, G-level, or B-level adjustments off? p.37 • Is the screen dirty? • Is the blackboard mode set properly? p.39 • Is the lamp nearing the end of its service life? p.45
Control panel key doesn't work	<ul style="list-style-type: none"> • Is the key lock function on? p.43

Troubleshooting (Continued)

If This Happens	Check
Remote control doesn't work	<ul style="list-style-type: none"> • Is the remote control code identical with the projector's code? p.44 • Are the remote control's batteries drained? • Are the batteries inserted into the remote control correctly? p.19 • Is the remote control being used within the effective range? p.19 • Are there any obstructions between the remote control and projector? • Are there any fluorescent or other bright lights directed at the projector's infrared remote sensor?
USB device images aren't projected	<ul style="list-style-type: none"> • Is the USB memory device inserted correctly? • Is a USB memory device not supported by the projector inserted? p.49 • Are there any JPEG or MPEG files saved on the USB memory device? • Are the files in an unsupported format or too large for the projector? For JPEG files, convert them with the supplied software application. p.83
The wireless LAN doesn't work	<ul style="list-style-type: none"> • Are the transmission mode, SSID, etc. properly configured? • Are there any obstructions between the computer and the projector? • Do your computer and operating system support the supplied software application? p.62

Specifications

■ List of general specifications

Item		Specification
Consumption Power		270 W
Weight		X3241N: 2.0 kg WX3231N: 1.9 kg
External Dimensions (including protruding parts)		295 × 82 × 196 mm (W × H × D)
Cabinet material		PC+ABS resin and PC resin (contains Mg alloy in some parts)
Conditions for usage environment		Temp: 5°C to 35°C; relative humidity: 30% to 70%
LCD Panel	Display method	3-panel transmission
	Panel size	X3241N: 0.7 type
		WX3231N: 0.59 type
	Drive system	TFT active matrix
Picture elements	X3241N: 786,432 pixels (1024 H × 768 V)	
	WX3231N: 1,024,000 pixels (1280 H × 800 V)	
Lens		X3241N: F=1.60 – 1.76 f=21.5 – 25.8 mm WX3231N: F=1.70 – 1.87 f=19.2 – 23.0 mm
Lamp		High-pressure mercury lamp (180 W)
Projection screen size		30-300 inches
Projection distance		X3241N: 0.89 m – 10.94 m WX3231N: 0.94 m – 11.58 m
Speaker		1 W (Mono)
Connection terminal	COMPUTER 1 IN terminal	Mini D sub 15 pin RGB / Y/P _B / P _R (dual use)
	COMPUTER 2 IN terminal	Mini D sub 15 pin RGB / Y/P _B / P _R / MONITOR OUT (multiple use)
	HDMI™ terminal	HDMI
	S-VIDEO terminal	Mini DIN 4 pin
	VIDEO terminal	RCA Pin Jack, 1 V (p-p), 75 Ω
	AUDIO IN terminal	3.5 mm diameter stereo mini-jack: 1.5 V (rms), 22 kΩ or more COMPUTER 1 IN / 2 IN/VIDEO/S-VIDEO (multiple use)
	AUDIO OUT terminal	3.5 mm diameter stereo mini-jack
	CONTROL terminal	D sub 9 pin (RS-232C)
	USB terminal	USB 2.0 High-speed enabled Type A; Output voltage: +5 VDC; Supply current: 500 mA
LAN terminal *	10BASE-T/100BASE-TX	

* When connecting a network cable, use a shielded cable.

■ Notes

- This model complies with the above specifications.
- Designs and specifications are subject to change without notice.
- This model may not be compatible with features and/or specifications that may be added in the future.

■ Separately sold product

- PJ Replacement Lamp Type1
- PJ Replacement Air filter Type1

Specifications (Continued)

List of supported signals (Computer input)

This projector supports the following RGB signals. Note, however, that depending on the computer model, the screen may show flicker or streaking. Please adjust the projector if this happens.

Resolution	Mode	Refresh rate (Hz)	H-frequency (kHz)	Clock (MHz)
720 x 400	720x400_85	85.039	37.927	35.500
640 x 480	VGA_60	59.940	31.469	25.175
	VGA_72	72.809	37.861	31.500
	VGA_75	75.000	37.500	31.500
	VGA_85	85.008	43.269	36.000
800 x 600	SVGA_56	56.250	35.156	36.000
	SVGA_60	60.317	37.879	40.000
	SVGA_72	72.188	48.077	50.000
	SVGA_75	75.000	46.875	49.500
	SVGA_85	85.061	53.674	56.250
832 x 624	MAC16"	74.550	49.725	57.283
1024 x 768	XGA_60	60.004	48.363	65.000
	XGA_70	70.069	56.476	75.000
	XGA_75	75.029	60.023	78.750
	XGA_85	84.997	68.667	94.500
	MAC19"	74.700	60.134	79.857
1152 x 864	SXGA1_75	75.000	67.500	108.000
*1280 x 800	WXGA_60	59.880	49.580	83.300
1280 x 960	QuadVGA_60	60.000	60.000	108.000
	QuadVGA_85	85.002	85.938	148.500
1280 x 1024	SXGA3_60	60.020	63.981	108.000
	SXGA3_75	75.025	79.976	135.000
	SXGA3_85	85.024	91.146	157.500
1400 x 1050	SXGA+	59.978	65.317	121.750
1600 x 1200	UXGA_60	60.000	75.000	162.000
	UXGA_65	65.000	81.250	175.500
	UXGA_70	70.000	87.500	189.000
	UXGA_75	75.000	93.750	202.500
	UXGA_85	85.000	106.250	229.500

* : 1280 x 800 is only available for WX3231N

Note

- Signals whose resolution exceeds the native resolution mentioned below will be compressed. For this reason, some information may be lost and/or image quality may be affected.

X3241N : 1024 x 768 dots

WX3231N : 1280 x 800 dots

■ List of supported signals (Y/P_B/P_R input)

Signal format	fh(kHz)	fv(Hz)
480i(525i)@60Hz	15.73	59.94
480p(525p)@60Hz	31.47	59.94
576i(625i)@50Hz	15.63	50.00
576p(625p)@50Hz	31.25	50.00
720p(750p)@60Hz	45.00	60.00
720p(750p)@50Hz	37.50	50.00
1080i(1125i)@60Hz	33.75	60.00
1080i(1125i)@50Hz	28.13	50.00
1080p(1125p)@60Hz	67.50	60.00
1080p(1125p)@50Hz	56.25	50.00

■ List of supported signals (Video, S-Video input)

Video mode	fh(kHz)	fv(Hz)	fsc(MHz)
NTSC	15.73	60	3.58
PAL	15.63	50	4.43
SECAM	15.63	50	4.25 or 4.41
PAL-M	15.73	60	3.58
PAL-N	15.63	50	3.58
PAL-60	15.73	60	4.43
NTSC4.43	15.73	60	4.43

■ List of supported signals (HDMI input)

Since the resolutions or frequencies input from a computer or picture device vary and may be different from the signals listed below, the images may not appear correctly or some signal formats may not be detected properly and even it may fail to display the images. If that happens, set your computer or the device so that an input signal listed below can be received.

Resolution	Mode	Refresh rate or V-frequency (Hz)	H-frequency (kHz)	Clock (MHz)
720 x 480	480p(525p)	59.94	31.469	27.000
720 x 576	576p(625p)	50.00	31.250	27.000
1280 x 720	720p(750p)	60.00	45.000	74.250
	720p(750p)	50.00	37.500	74.250
1920 x 1080	1080i(1125i)	60.00	33.750	74.250
	1080i(1125i)	50.00	28.125	74.250
	1080p(1125p)	60.00	67.500	148.50
	1080p(1125p)	50.00	56.250	148.50
640 x 480	VGA_60	59.940	31.469	25.175
	VGA_72	72.809	37.861	31.500
	VGA_75	75.000	37.500	31.500
800 x 600	SVGA_60	60.317	37.879	40.000
	SVGA_72	72.188	48.077	50.000
	SVGA_75	75.000	46.875	49.500
1024 x 768	XGA_60	60.004	48.363	65.000
	XGA_70	70.069	56.476	75.000
	XGA_75	75.029	60.023	78.750
* 1280 x 800	WXGA_60	59.880	49.580	83.300
1280 x 1024	SXGA3_60	60.020	63.981	108.000
1400 x 1050	SXGA+	59.978	65.317	121.750

* : 1280 x 800 is only available for WX3231N

Specifications (Continued)

■ Pin assignment of COMPUTER 1 IN, COMPUTER 2 IN and MONITOR terminals

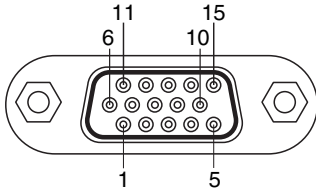

Mini D sub 15 Pin connector

Input Signal

- RGB input
 RGB signals: 0.7 V (p-p) 75 Ω
 Horizontal sync signal: TTL level (Pos/neg polarity)
 Vertical sync signal: TTL level (Pos/neg polarity)
- Y/P_B/P_R input
 Y signal: 1.0 V (p-p) 75 Ω
 P_B/P_R signals: 0.7 V (p-p) 75 Ω

Pin No.	Pin description	
	During RGB input	During Y/P _B /P _R input
1	Video signal (R)	Color difference signal (P _R)
2	Video signal (G)	Luminance signal (Y)
3	Video signal (B)	Color difference signal (P _B)
4	GND	*
5	GND	*
6	GND(R)	GND(P _R)
7	GND(G)	GND(Y)
8	GND(B)	GND(P _B)
9	N.C	*
10	GND	*
11	GND	*
12	N.C	*
13	Horizontal sync signal	*
14	Vertical sync signal	*
15	N.C	*

* Do not connect anything.

■ CONTROL terminal

● Pin assignment

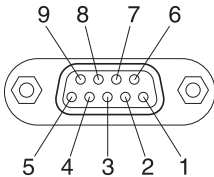

D sub 9 pin connector

Pin No.	Signal Name	Description
1	DCD	Data carrier detect
2	TXD	Sending data
3	RXD	Receiving data
4	DTR	Data terminal ready
5	GND	Signal ground
6	DSR	Data set ready
7	RTS	Request to send
8	CTS	Consent to send
9	RI	Ring indicator

● Interface format

1. Communication method RS-232C, 9600 bps, No Parity, Data Length: 8 bits;
Stop Bit Length: 1 bit
2. Communication format

STX (02 h)	Command (3 Byte)	ETX (03 h)
------------	------------------	------------

Only 1 command valid per communication.
3. Data format For input commands, only ASCII-compliant all-
uppercase alphanumeric characters supported.
4. Replies Acknowledge

ACK (06 h)	CR(0 Dh)	Data
------------	----------	------

 ... Normally ended
- | | |
|------------|-----------|
| ACK (06 h) | ESC(1 Bh) |
|------------|-----------|

 ... Aborted
- No acknowledge

NAK (15 h)

If commands are to be sent consecutively, wait for the response from the projector before sending the next command.

● Main Commands

Item	Command
Power on	PON
Power off	POF
Icon display on	MO0
Icon display off	MO1
Auto setting (RGB input)	PAT
Status display on	DON
Status display off	DOF

